

iHFG Standard Components

Room Layout Sheet

RLS Room Code

beqp-12-i

RDS Room Code

beqp-12-i

Room Name **Bay - Equipment Park, 12m2**

CG	CORNER GUARD
CR	CRASH RAIL
IVS	IV STAND - MOBILE
L/LL	LIGHT - LED LIGHT
PB	PLASTERBOARD FLUSH SET CEILING, PAINT FINISH
PO/2	POWER OUTLET - DOUBLE
SHL	SHELF - LAMINATED
SK4	FLOOR VINYL COVERED SKIRTING
T	TROLLEY
T/E	TROLLEY - EQUIPMENT
V1	VINYL FLOORING, STANDARD SLIP RESISTANT
WCH	WHEELCHAIR
WPF	WALL PAINT FINISH

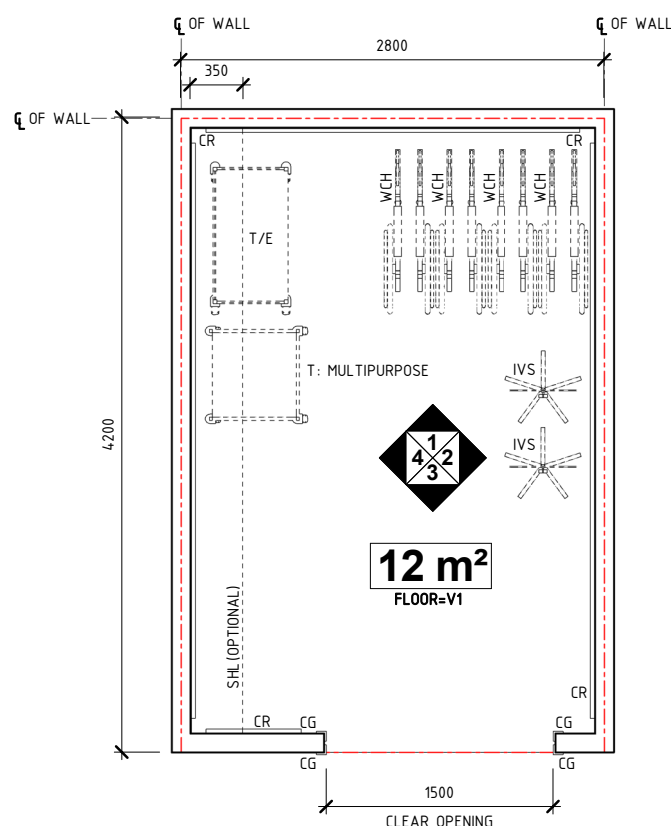

PLAN

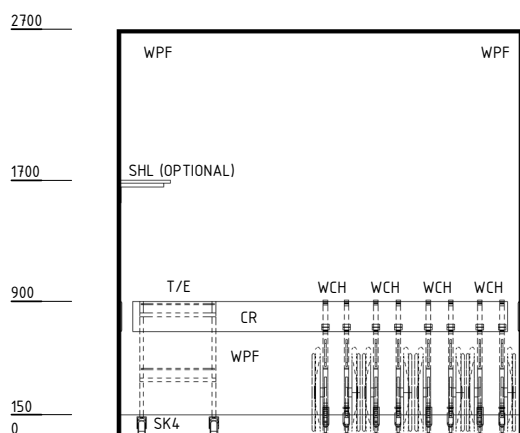

ELEVATION 1

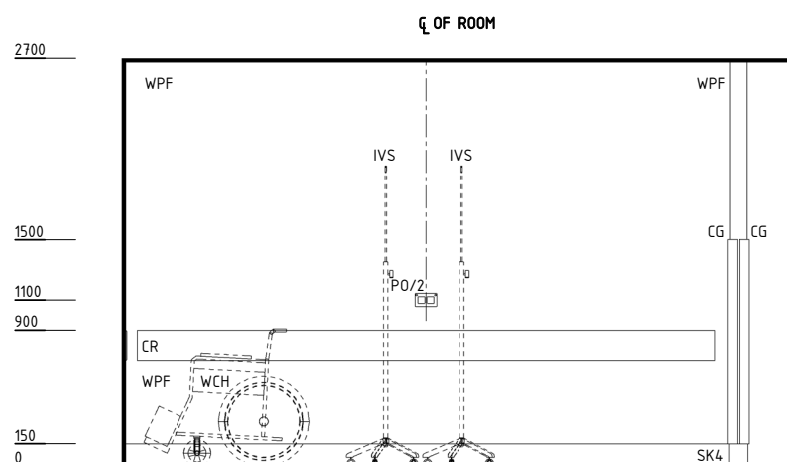

ELEVATION 2

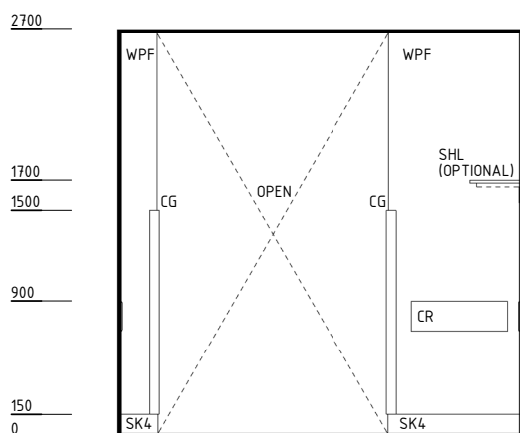

ELEVATION 3

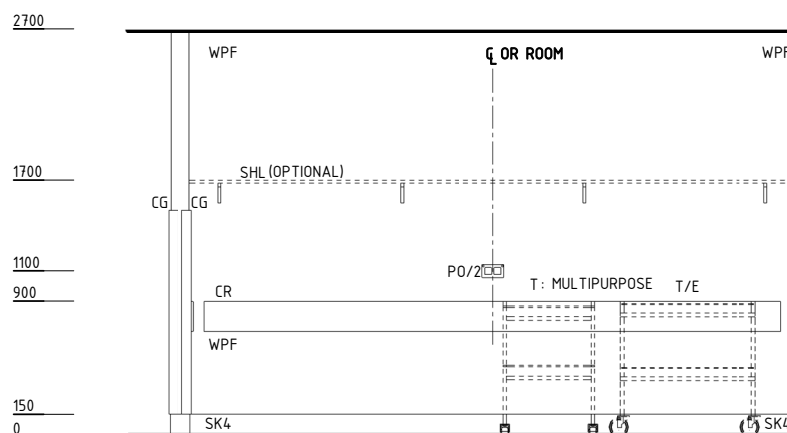

ELEVATION 4

REV	DESCRIPTION	DATE	BY	REV	DESCRIPTION	DATE	BY	COMPATIBILITY
1	FIRST ISSUE	24.10.10	CC	4	GENERAL REVISION	30.12.22	RA	iHFG
2	GENERAL REVISION	30.08.11	ASD					
3	GENERAL REVISION	31.10.12	CT					



International Health Facility Guidelines at:
www.healthdesign.com.au/iHFG
 Editable version of Standard Components on
 Health Facility Briefing System (HFBS) at:
www.healthdesign.com.au ©TAHPI



DESIGNED	APPROVED	DATE	SCALE(S)	SHEET
RA	RH	30.12.22	1 : 50	1 OF 3
REVIT FILE NAME		PAPER DRAWING ID		ISSUE
beqp-12-i		beqp-12-i-1		4

iHFG Standard Components

Room Layout Sheet

RLS Room Code

beqp-12-i

RDS Room Code

beqp-12-i

Room Name **Bay - Equipment Park, 12m2**

GENERAL NOTES:

THIS DRAWING TO BE READ IN CONJUNCTION WITH R.D.S. (ROOM DATA SHEETS) WHICH TAKES PRECEDENCE.

ALL SERVICES INDICATED ARE INDICATIVE AND SUBJECTED TO DETAILED PROJECT SPECIFIC ENGINEERING DESIGN.

CEILING LEGEND:



PB PLASTERBOARD, FLUSH SET, PAINT FINISH
 --- GRID LINE

ELECTRICAL LEGEND:

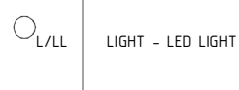

MECHANICAL LEGEND:



FIRE SERVICES LEGEND:

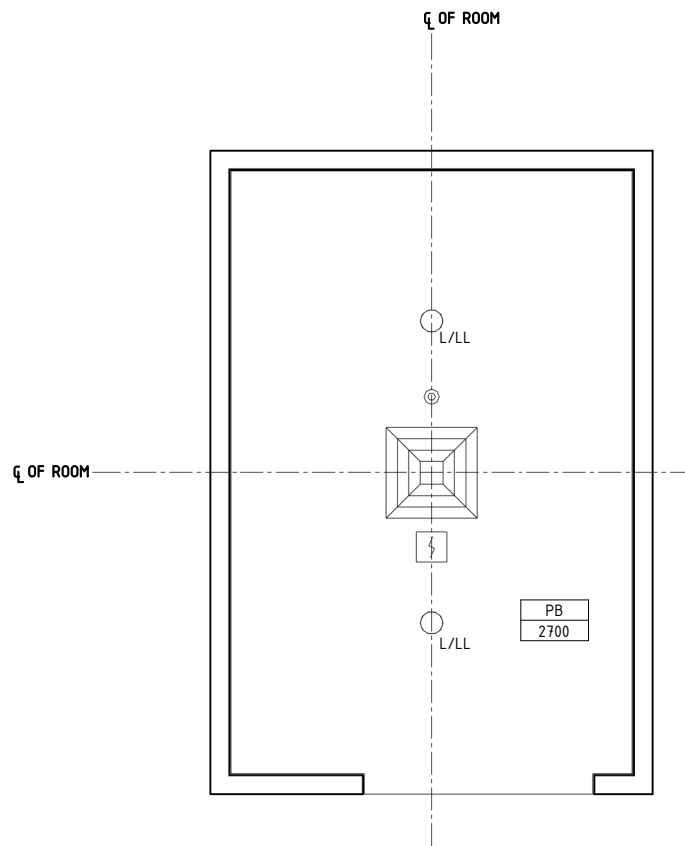
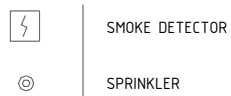

REFLECTED CEILING PLAN

REV	DESCRIPTION	DATE	BY	REV	DESCRIPTION	DATE	BY	COMPATIBILITY
1	FIRST ISSUE	24.10.10	CC	4	GENERAL REVISION	30.12.22	RA	iHFG
2	GENERAL REVISION	30.08.11	ASD					
3	GENERAL REVISION	31.10.12	CT					

DESIGNED	APPROVED	DATE	SCALE(S)	SHEET
RA	RH	30.12.22	1 : 50	2 OF 3
REVIT FILE NAME		PAPER DRAWING ID		ISSUE
beqp-12-i		beqp-12-i-2		4

iHFG Standard Components

Room Layout Sheet

Room Name | Bay - Equipment Park, 12m2

RLS Room Code

beqp-12-i

RDS Room Code

beqp-12-i

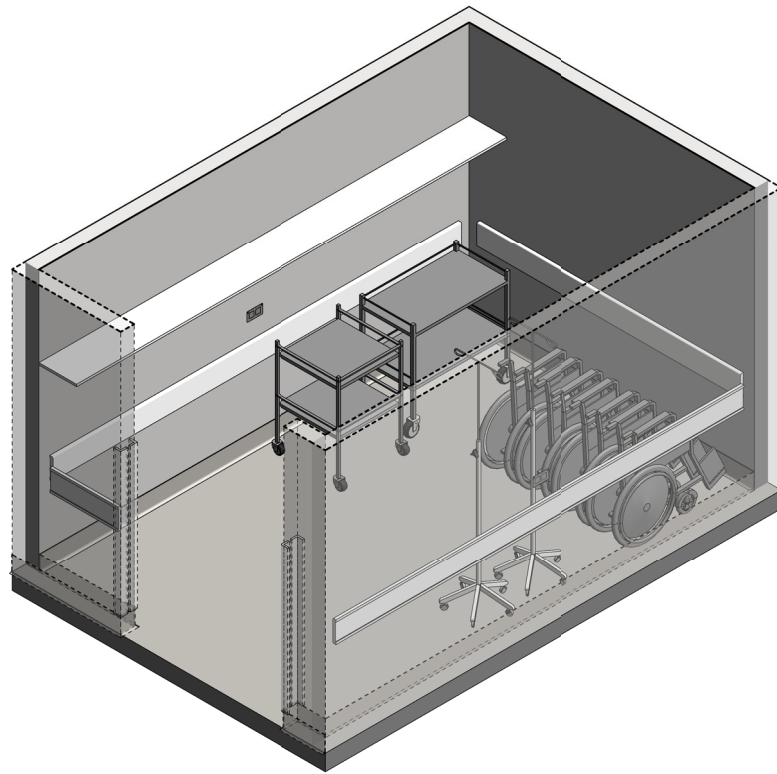

ISOMETRIC VIEW 1

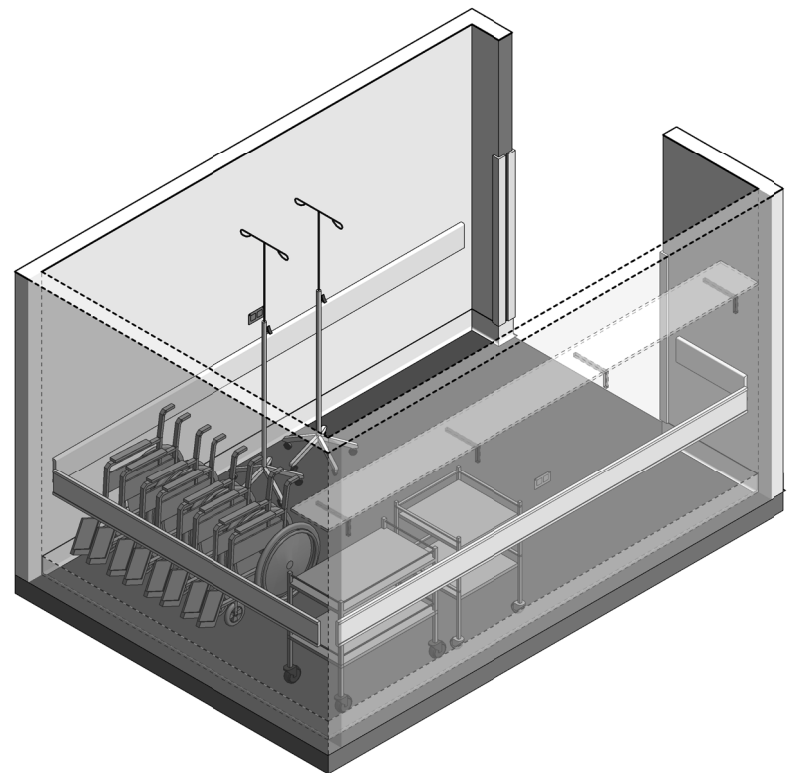

ISOMETRIC VIEW 2

REV	DESCRIPTION	DATE	BY	REV	DESCRIPTION	DATE	BY	COMPATIBILITY																								
1	FIRST ISSUE	24.10.10	CC	4	GENERAL REVISION	30.12.22	RA	iHFG																								
2	GENERAL REVISION	30.08.11	ASD																													
3	GENERAL REVISION	31.10.12	CT																													
<table border="1"> <thead> <tr> <th>DESIGNED</th> <th>APPROVED</th> <th>DATE</th> <th>SCALE(S)</th> <th>SHEET</th> </tr> </thead> <tbody> <tr> <td>RA</td> <td>RH</td> <td>30.12.22</td> <td></td> <td>3 OF 3</td> </tr> <tr> <td colspan="2"> <table border="1"> <thead> <tr> <th>REVIT FILE NAME</th> <th>PAPER DRAWING ID</th> <th>ISSUE</th> </tr> </thead> <tbody> <tr> <td>beqp-12-i</td> <td>beqp-12-i-3</td> <td>4</td> </tr> </tbody> </table> </td> <td colspan="2"></td> <td></td> </tr> </tbody> </table>								DESIGNED	APPROVED	DATE	SCALE(S)	SHEET	RA	RH	30.12.22		3 OF 3	<table border="1"> <thead> <tr> <th>REVIT FILE NAME</th> <th>PAPER DRAWING ID</th> <th>ISSUE</th> </tr> </thead> <tbody> <tr> <td>beqp-12-i</td> <td>beqp-12-i-3</td> <td>4</td> </tr> </tbody> </table>		REVIT FILE NAME	PAPER DRAWING ID	ISSUE	beqp-12-i	beqp-12-i-3	4				<p>International Health Facility Guidelines at: www.healthdesign.com.au/iHFG Editable version of Standard Components on Health Facility Briefing System (HFBS) at: www.healthdesign.com.au @TAHPI</p>			
DESIGNED	APPROVED	DATE	SCALE(S)	SHEET																												
RA	RH	30.12.22		3 OF 3																												
<table border="1"> <thead> <tr> <th>REVIT FILE NAME</th> <th>PAPER DRAWING ID</th> <th>ISSUE</th> </tr> </thead> <tbody> <tr> <td>beqp-12-i</td> <td>beqp-12-i-3</td> <td>4</td> </tr> </tbody> </table>		REVIT FILE NAME	PAPER DRAWING ID	ISSUE	beqp-12-i	beqp-12-i-3	4																									
REVIT FILE NAME	PAPER DRAWING ID	ISSUE																														
beqp-12-i	beqp-12-i-3	4																														

This document is for advisory purpose only