

iHFG Standard Components

Room Layout Sheet

RLS Room Code

bflw-enc-i

RDS Room Code

bflw-enc-i

Room Name

Bay - Flowers, Enclosed

AS	ADJUSTABLE SHELF
BH/PB	BULKHEAD - PLASTERBOARD, PAINT FINISH
BNL	BENCH - LAMINATE
CBD/UB	CUPBOARD - UNDER BENCH
DFP	DOOR AND DOOR FRAME PROTECTION
DHT	DISPENSER - PAPER HAND TOWEL
DS	DISPENSER - SOAP
L/LL	LIGHT - LED LIGHT
LS/R	LIGHT SWITCH - ROOM
OP	OBSERVATION PANEL
PO/2	POWER OUTLET - DOUBLE
SBK	SPLASHBACK
SG	SAFETY GLASS
SK4	FLOOR VINYL COVED SKIRTING
SNK12	SINK WITH DRAINER - SINGLE
SUA	SHELVING UNIT - ADJUSTABLE
TAP/M	TAPWARE - MIXER
V1	VINYL FLOORING, STANDARD SLIP RESISTANT
WBG	WASTE BIN - GENERAL
WPF	WALL PAINT FINISH

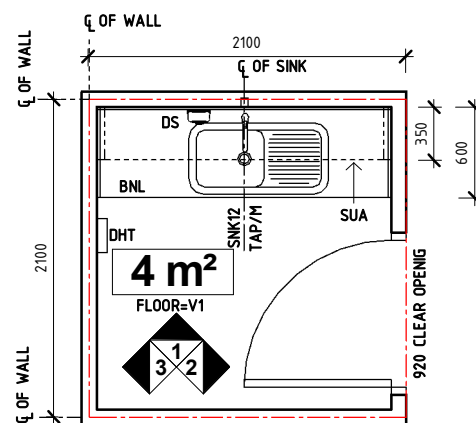

PLAN

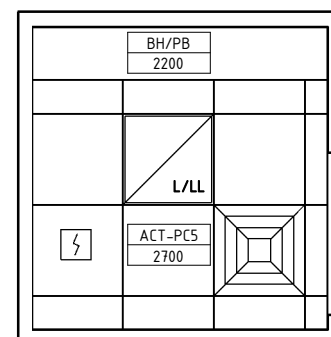

REFLECTED CEILING PLAN

GENERAL NOTES:

THIS DRAWING TO BE READ IN CONJUNCTION WITH R.D.S. (ROOM DATA SHEETS) WHICH TAKES PRECEDENCE.

ALL SERVICES INDICATED ARE INDICATIVE AND SUBJECT TO DETAILED PROJECT SPECIFIC ENGINEERING DESIGN.

CEILING LEGEND:



ACT-PCS | ACOUSTIC CEILING TILES WITH POWDERCOAT ALUMINIUM CORNICE, FLUSHED AGAINST WALL

BH/PB | PLASTERBOARD BULKHEAD, PAINT FINISH

ELECTRICAL LEGEND:

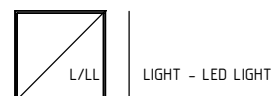

MECHANICAL LEGEND:



FIRE SERVICES LEGEND:

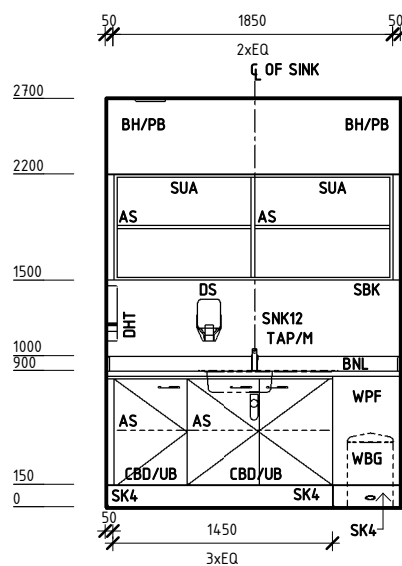
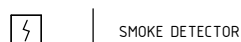

ELEVATION 1

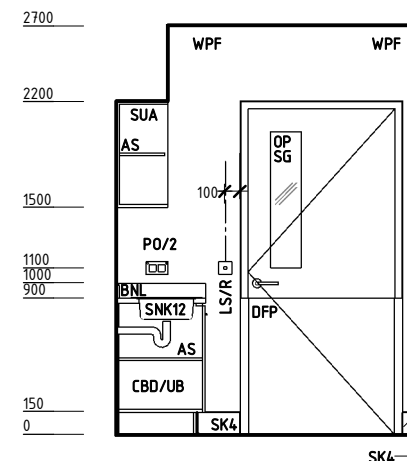

ELEVATION 2

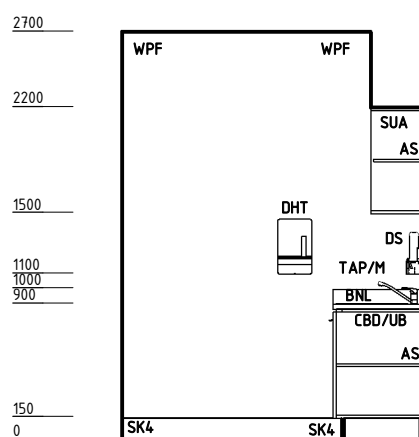

ELEVATION 3

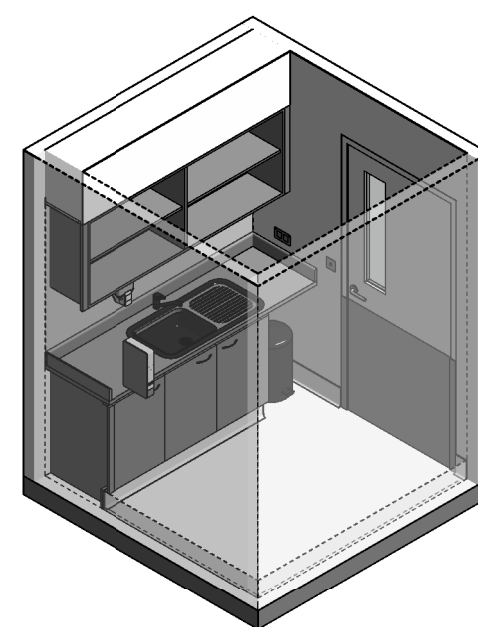

ISOMETRIC VIEW

REV	DESCRIPTION	DATE	BY	REV	DESCRIPTION	DATE	BY	COMPATIBILITY
1	FIRST ISSUE	24.10.10	LL	4	GENERAL REVISION	25.05.23	SS	iHFG
2	GENERAL REVISION	30.08.11	HMC					
3	GENERAL REVISION	31.10.12	CT					



International Health Facility Guidelines at: www.healthdesign.com.au/iHFG
 Editable version of Standard Components on Health Facility Briefing System (HFBS) at: www.healthdesign.com.au ©TAHPI



DESIGNED	APPROVED	DATE	SCALE(S)	SHEET
SS	SA	25.05.23	1 : 50	1 OF 1
REVIT FILE NAME		PAPER DRAWING ID		ISSUE
bflw-enc-i		bflw-enc-i-1		4