

iHFG Standard Components

Room Layout Sheet

RLS Room Code

body-h-i

RDS Room Code

body-h-i

Room Name **Holding Room (Bodies)**

DDG	DISPENSER - DISPOSABLE GLOVES
DFP	DOOR AND DOOR FRAME PROTECTION
DHS	DISPENSER - HAND SANITISER
DHT	DISPENSER - PAPER HAND TOWEL
DS	DISPENSER - SOAP
DSA	DISPENSER - SOAP, ANTISEPTIC
HWB/B	HAND WASH BASIN - TYPE 'B'
LS/R	LIGHT SWITCH - ROOM
PO/2	POWER OUTLET - DOUBLE
PO/C	POWER OUTLET - CLEANER'S
SK4	FLOOR VINYL COVERED SKIRTING
T/MH	TROLLEY - MORTUARY, HYDRAULIC
TAP/ST	TAPWARE - SENSOR TAP
V1	VINYL FLOORING, STANDARD SLIP RESISTANT
V6	VINYL FLOORING, NON SLIP - TEXTURED
WBG/20	WASTE BIN - GENERAL, 20 LITRE
WPF	WALL PAINT FINISH
WV	WALL VINYL

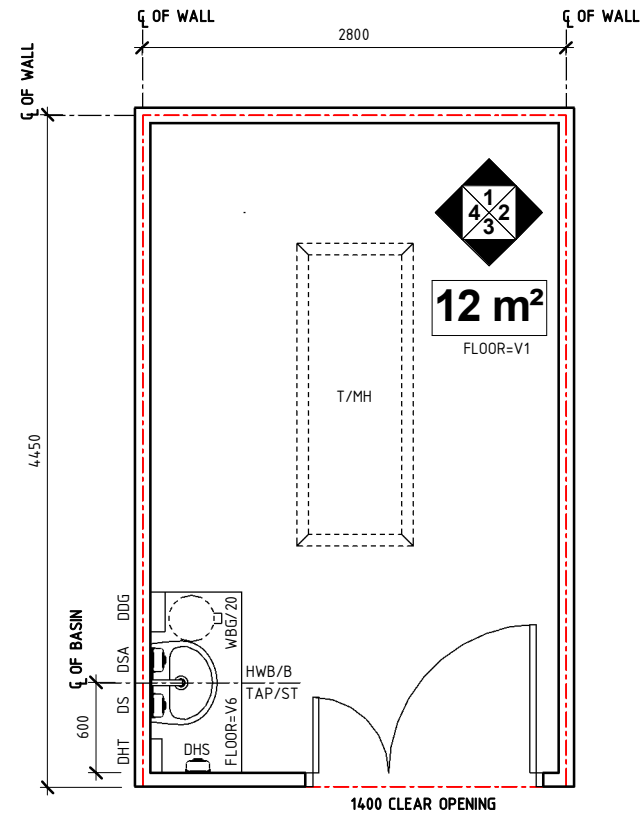

PLAN

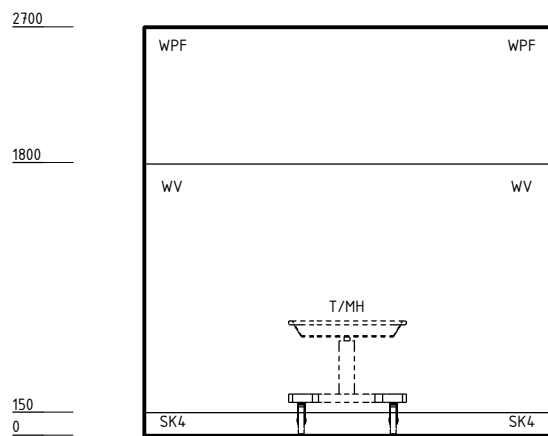

ELEVATION 1

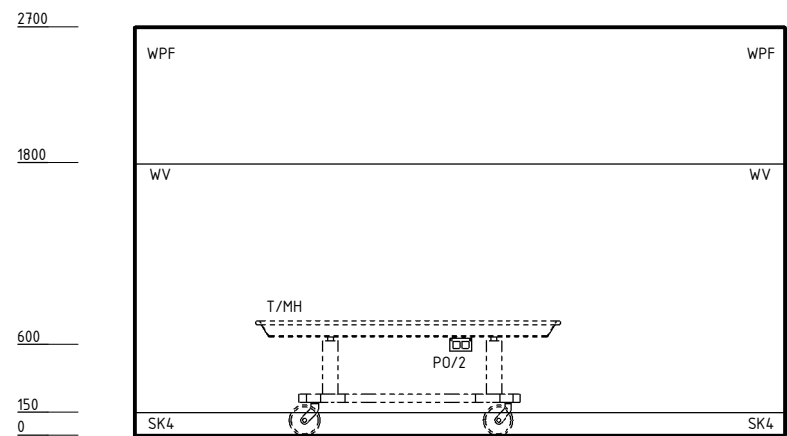

ELEVATION 2

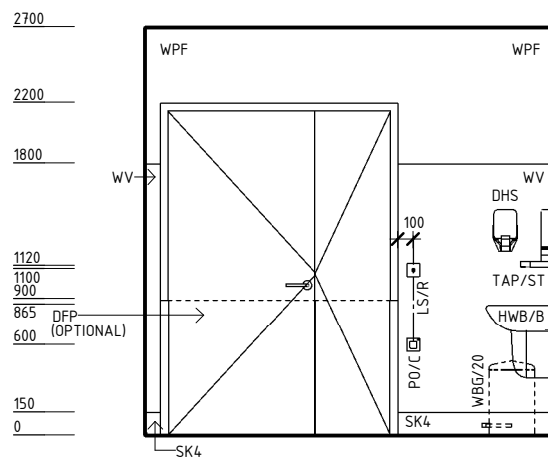

ELEVATION 3

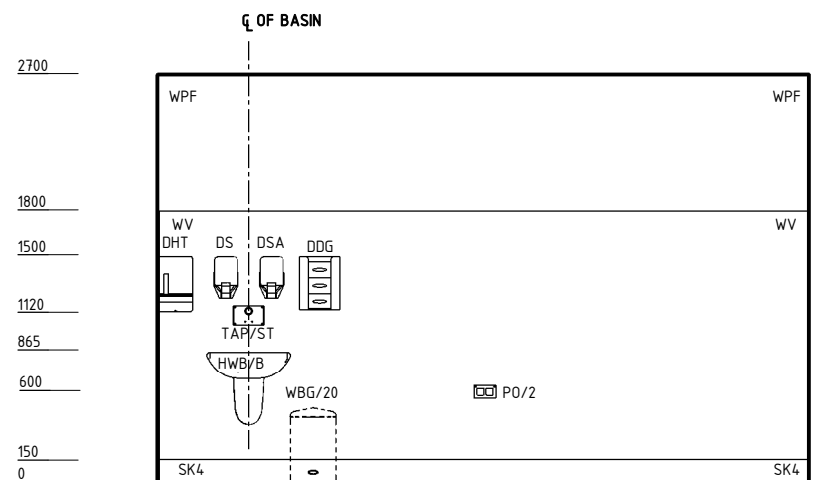

ELEVATION 4

REV	DESCRIPTION	DATE	BY	REV	DESCRIPTION	DATE	BY	COMPATIBILITY
1	FIRST ISSUE	25.05.23	AM					iHFG

iHFG Standard Components

Room Layout Sheet

RLS Room Code

body-h-i

RDS Room Code

body-h-i

Room Name **Holding Room (Bodies)**

GENERAL NOTES:

THIS DRAWING TO BE READ IN CONJUNCTION WITH R.D.S. (ROOM DATA SHEETS) WHICH TAKES PRECEDENCE.

ALL SERVICES INDICATED ARE INDICATIVE AND SUBJECTED TO DETAILED PROJECT SPECIFIC ENGINEERING DESIGN.

CEILING LEGEND:

	CEILING TYPE CORNICIE TYPE HEIGHT ABOVE F.F.L.
PB-PC4	PLASTERBOARD FLUSH SET CEILING, PAINT FINISH WITH POWDERCOAT ALUMINIUM CORNICIE, SHADOW LINE
---	GRID LINE

ELECTRICAL LEGEND:

	LIGHT - DOWNLIGHT, RECESSED
	LIGHT - LED LIGHT

MECHANICAL LEGEND:

	SUPPLY AIR GRILLE
	RETURN AIR GRILLE

FIRE SERVICES LEGEND:

	SMOKE DETECTOR
	SPRINKLER

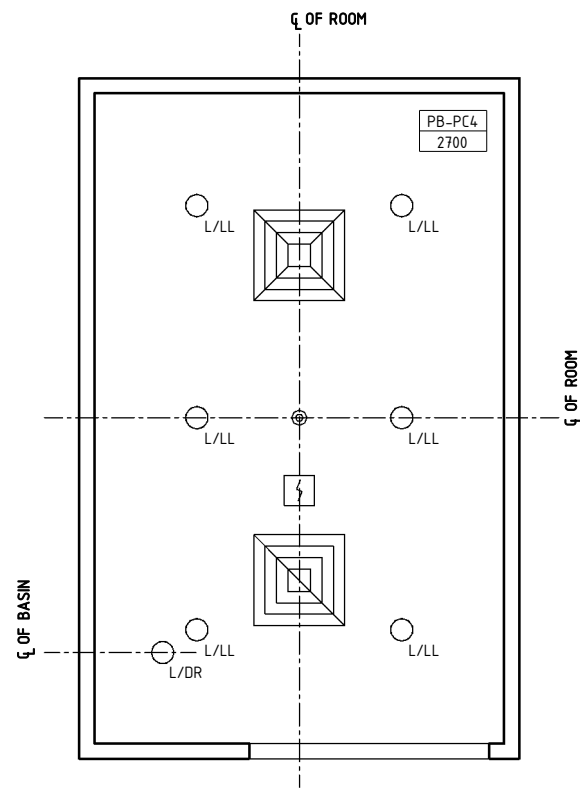

REFLECTED CEILING PLAN

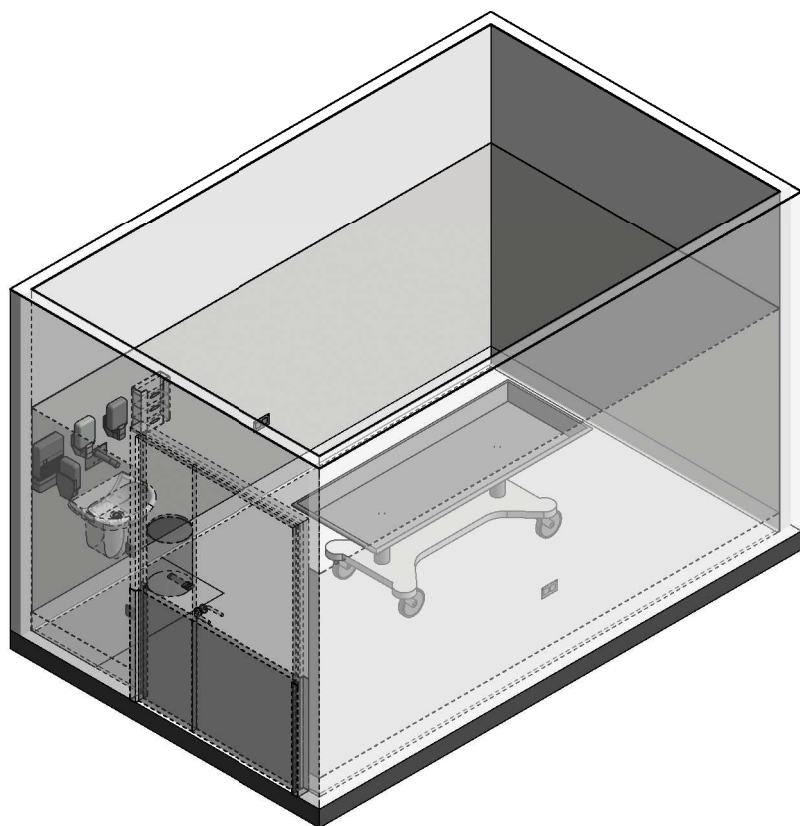

ISOMETRIC VIEW 1

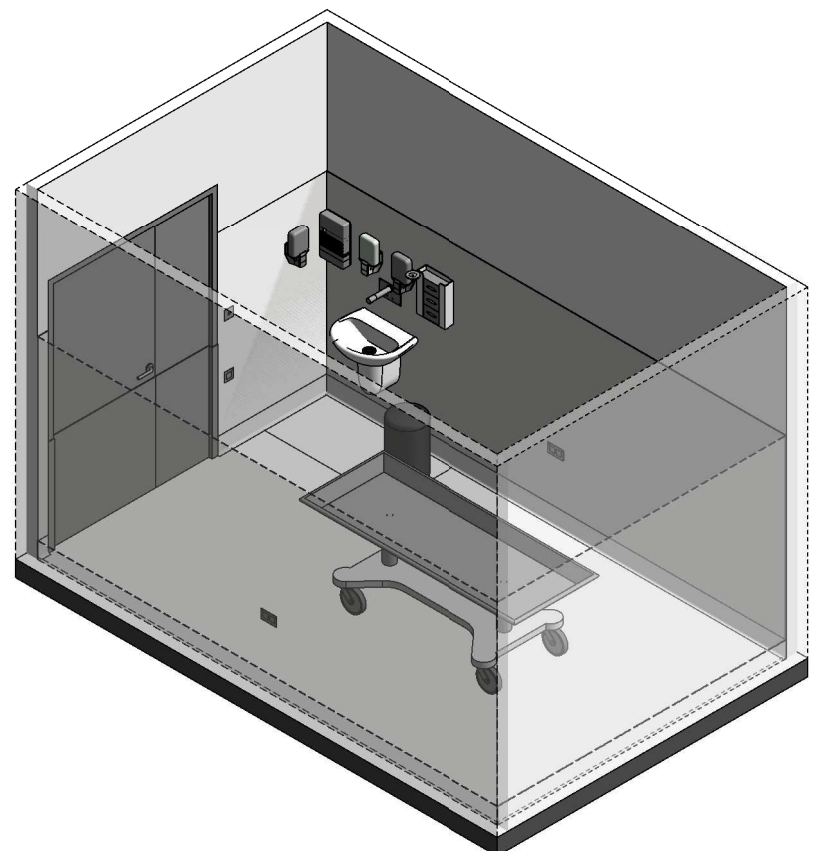

ISOMETRIC VIEW 2

REV	DESCRIPTION	DATE	BY	REV	DESCRIPTION	DATE	BY	COMPATIBILITY																				
1	FIRST ISSUE	25.05.23	AM					iHFG																				
								<table border="1"> <tr> <th>DESIGNED</th> <th>APPROVED</th> <th>DATE</th> <th>SCALE(S)</th> <th>SHEET</th> </tr> <tr> <td>AM</td> <td>SA</td> <td>25.05.23</td> <td>1 : 50</td> <td>2 OF 2</td> </tr> <tr> <td colspan="2">REVIT FILE NAME</td> <td colspan="2">PAPER DRAWING ID</td> <td>ISSUE</td> </tr> <tr> <td colspan="2">body-h-i</td> <td colspan="2">body-h-i-2</td> <td>1</td> </tr> </table>	DESIGNED	APPROVED	DATE	SCALE(S)	SHEET	AM	SA	25.05.23	1 : 50	2 OF 2	REVIT FILE NAME		PAPER DRAWING ID		ISSUE	body-h-i		body-h-i-2		1
DESIGNED	APPROVED	DATE	SCALE(S)	SHEET																								
AM	SA	25.05.23	1 : 50	2 OF 2																								
REVIT FILE NAME		PAPER DRAWING ID		ISSUE																								
body-h-i		body-h-i-2		1																								