

iHFG Standard Components

Room Layout Sheet

RLS Room Code

deni-16-i

RDS Room Code

deni-16-i

Room Name **Dental Imaging Room, 16m2**

CHR/E	CHAIR - ERGONOMIC, OFFICE
CHR/P	CHAIR - PATIENT
COM/1	COMMUNICATION OUTLET - SINGLE
COM/2	COMMUNICATION OUTLET - DOUBLE
D/XU	DENTAL - X-RAY UNIT
DFP	DOOR AND DOOR FRAME PROTECTION
DK/BI	DESK - BUILT IN
EC	EMERGENCY CALL
GL	GLAZING
LS/R	LIGHT SWITCH - ROOM
OP/R	OBSERVATION PANEL - RADIATION SHIELDING
PO/2	POWER OUTLET - DOUBLE
PO/2E	POWER OUTLET - EMERGENCY, DOUBLE
R/LA	RACK - LEAD APRON
SK4	FLOOR VINYL COVERED SKIRTING
TP/WM	TELEPHONE - WALL MOUNTED
V1	VINYL FLOORING, STANDARD SLIP RESISTANT
WBG/20	WASTE BIN - GENERAL, 20 LITRE
WPF	WALL PAINT FINISH

NOTE:
RADIATION SHIELDING REQUIREMENTS TO BE PROVIDED BY A QUALIFIED RADIATION SHIELDING CONSULTANT

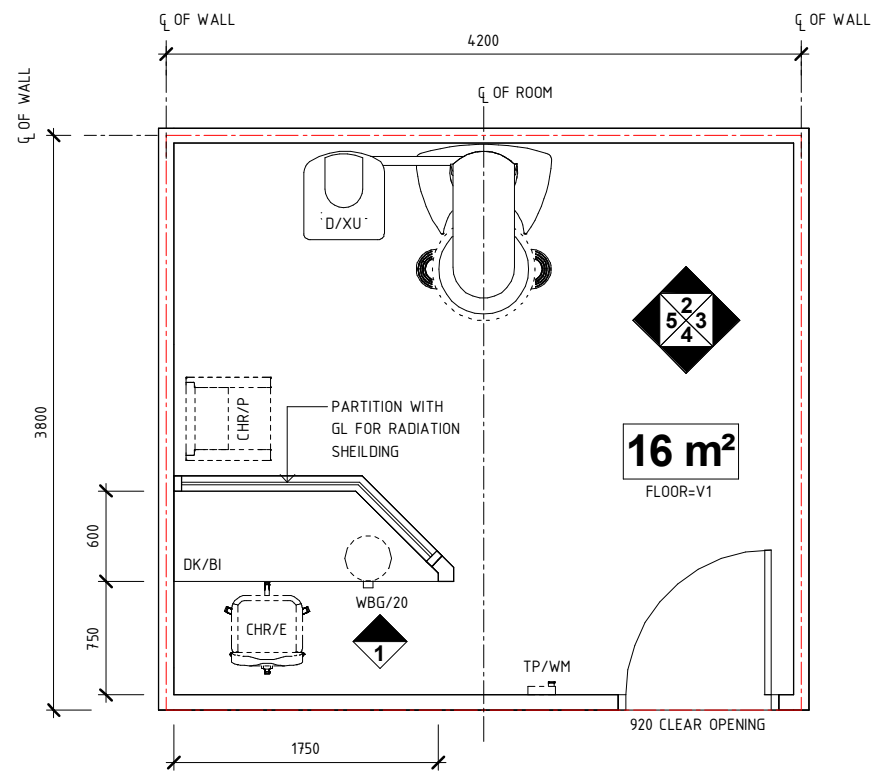

PLAN

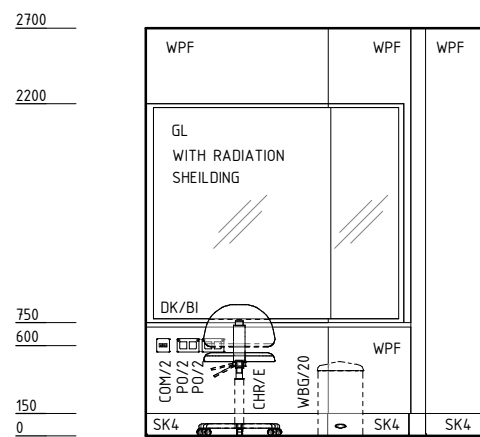

ELEVATION 1

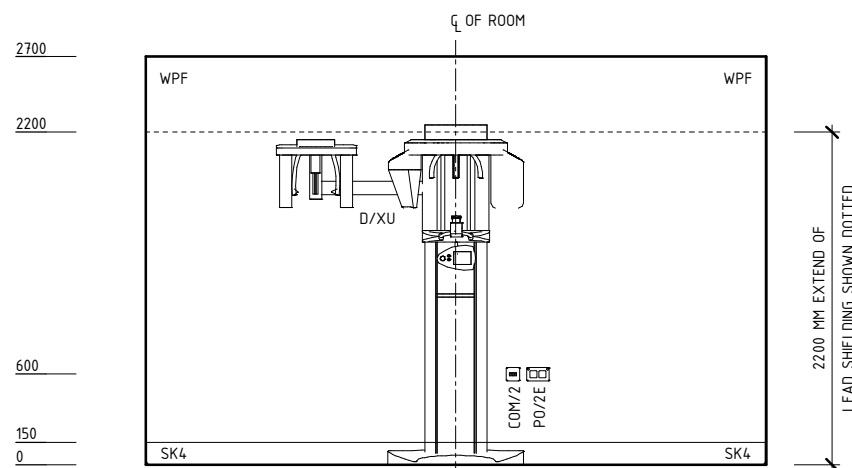

ELEVATION 2

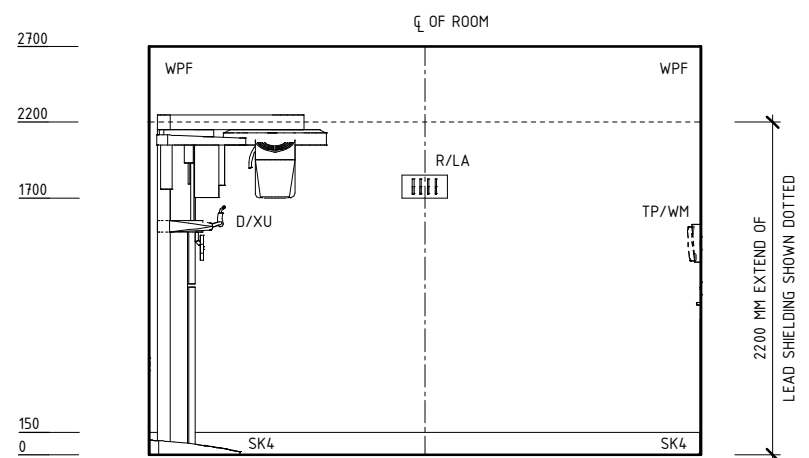

ELEVATION 3

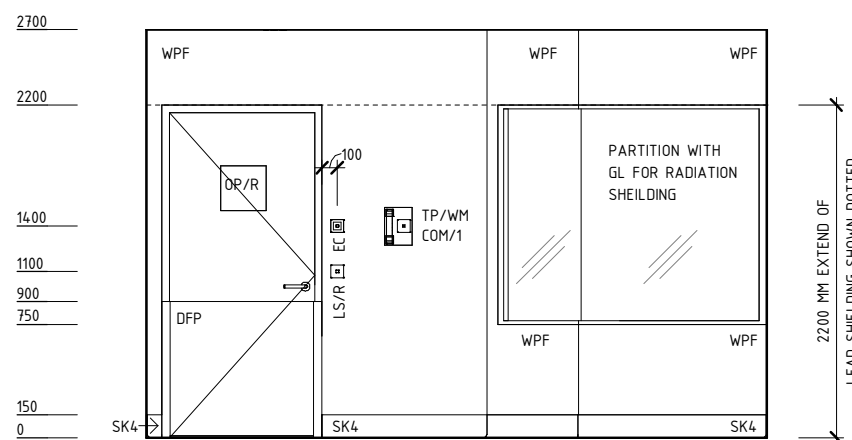

ELEVATION 4

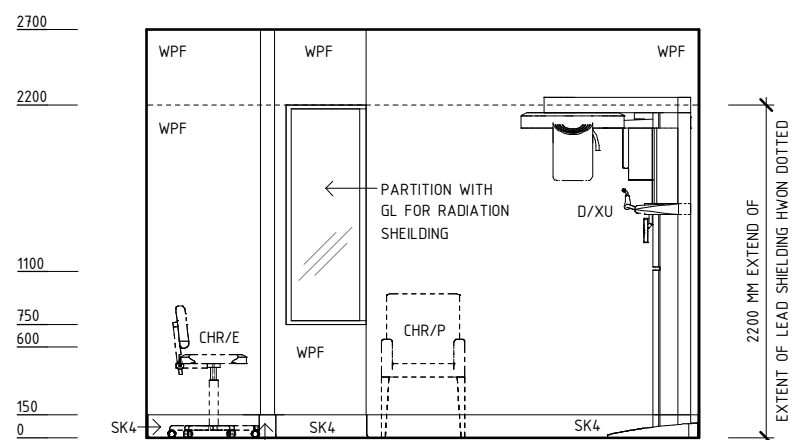

ELEVATION 5

REV	DESCRIPTION	DATE	BY	REV	DESCRIPTION	DATE	BY	COMPATIBILITY																				
1	FIRST ISSUE	27.01.23	SS					iHFG																				
								<table border="1"> <tr> <td>DESIGNED</td> <td>APPROVED</td> <td>DATE</td> <td>SCALE(S)</td> <td>SHEET</td> </tr> <tr> <td>SS</td> <td>SA</td> <td>27.01.23</td> <td>1 : 50</td> <td>1 OF 2</td> </tr> <tr> <td colspan="2">REVIT FILE NAME</td> <td colspan="2">PAPER DRAWING ID</td> <td>ISSUE</td> </tr> <tr> <td colspan="2">deni-16-i</td> <td colspan="2">deni-16-i-1</td> <td>1</td> </tr> </table>	DESIGNED	APPROVED	DATE	SCALE(S)	SHEET	SS	SA	27.01.23	1 : 50	1 OF 2	REVIT FILE NAME		PAPER DRAWING ID		ISSUE	deni-16-i		deni-16-i-1		1
DESIGNED	APPROVED	DATE	SCALE(S)	SHEET																								
SS	SA	27.01.23	1 : 50	1 OF 2																								
REVIT FILE NAME		PAPER DRAWING ID		ISSUE																								
deni-16-i		deni-16-i-1		1																								

iHFG Standard Components

Room Layout Sheet

RLS Room Code

deni-16-i

RDS Room Code

deni-16-i

Room Name **Dental Imaging Room, 16m2**

GENERAL NOTES:

THIS DRAWING TO BE READ IN CONJUNCTION WITH R.D.S. (ROOM DATA SHEETS) WHICH TAKES PRECEDENCE.

ALL SERVICES INDICATED ARE INDICATIVE AND SUBJECT TO DETAILED PROJECT SPECIFIC ENGINEERING DESIGN.

CEILING LEGEND:

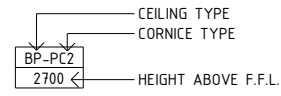

ACT-PC4 ACOUSTIC CEILING TILES WITH POWDERCOAT ALUMINIUM CORNICE, SHADOW LINE

TILE CEILING GRID (600 x 600)

GRID LINE

ELECTRICAL LEGEND:

L/CCD LIGHT - COLOUR CORRECTED, DIMMABLE

MECHANICAL LEGEND:

SUPPLY AIR GRILLE

RETURN AIR GRILLE

FIRE SERVICES LEGEND:

SMOKE DETECTOR

SPRINKLER

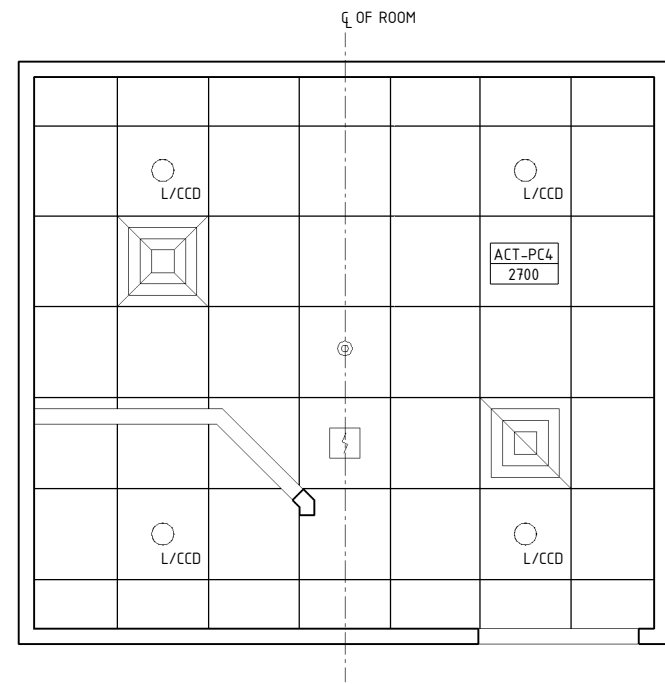

REFLECTED CEILING PLAN



ISOMETRIC VIEW 01

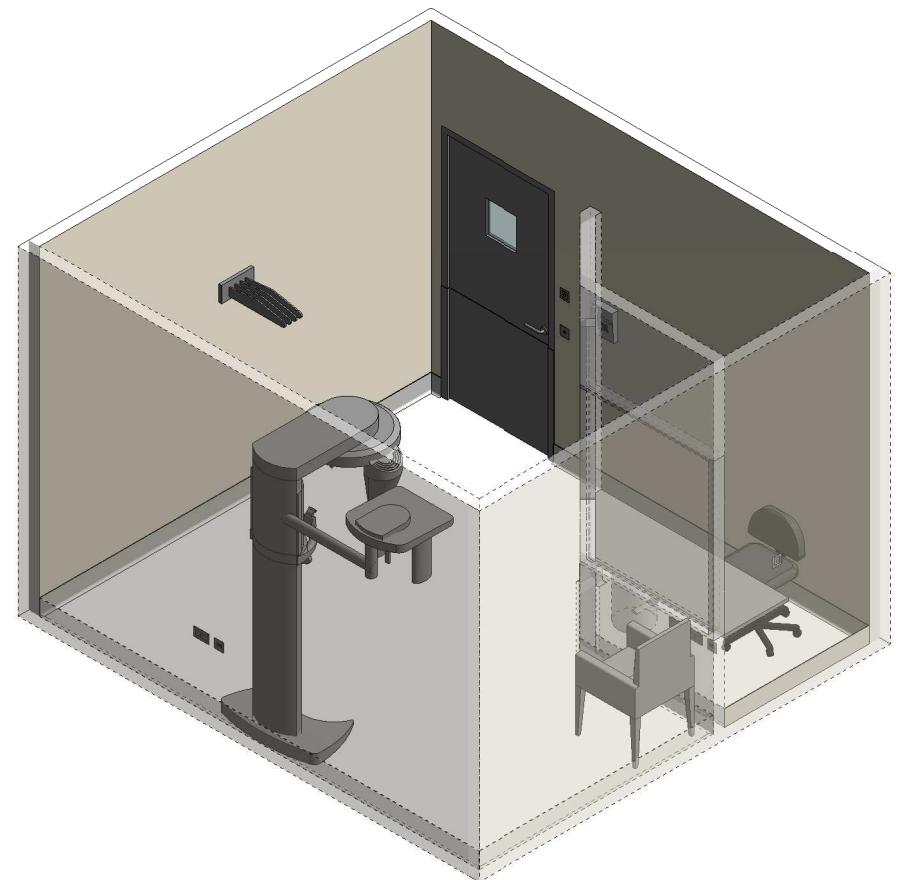

ISOMETRIC VIEW 02

REV	DESCRIPTION	DATE	BY	REV	DESCRIPTION	DATE	BY	COMPATIBILITY																				
1	FIRST ISSUE	27.01.23	SS					iHFG																				
								<table border="1"> <thead> <tr> <th>DESIGNED</th> <th>APPROVED</th> <th>DATE</th> <th>SCALE(S)</th> <th>SHEET</th> </tr> </thead> <tbody> <tr> <td>SS</td> <td>SA</td> <td>27.01.23</td> <td>1 : 50</td> <td>2 OF 2</td> </tr> <tr> <td colspan="2">REVIT FILE NAME</td> <td colspan="2">PAPER DRAWING ID</td> <td>ISSUE</td> </tr> <tr> <td colspan="2">deni-16-i</td> <td colspan="2">deni-16-i-2</td> <td>1</td> </tr> </tbody> </table>	DESIGNED	APPROVED	DATE	SCALE(S)	SHEET	SS	SA	27.01.23	1 : 50	2 OF 2	REVIT FILE NAME		PAPER DRAWING ID		ISSUE	deni-16-i		deni-16-i-2		1
DESIGNED	APPROVED	DATE	SCALE(S)	SHEET																								
SS	SA	27.01.23	1 : 50	2 OF 2																								
REVIT FILE NAME		PAPER DRAWING ID		ISSUE																								
deni-16-i		deni-16-i-2		1																								



International Health Facility Guidelines at:
www.healthdesign.com.au/iHFG
Editable version of Standard Components on
Health Facility Briefing System (HFBS) at:
www.healthdesign.com.au @TAHPI

