

iHFG Standard Components

Room Layout Sheet

RLS Room Code

hydIk-i

RDS Room Code

hydIk-i

Room Name | **Hydrotherapy Pool Locker Bay**

- BNS BENCH SEAT
- CG CORNER GUARD
- LK/2 LOCKER - 2 TIER
- SK9 TILE COVED SKIRTING
- TL TILE FLOORING
- WPF WALL PAINT FINISH

OPTION 1

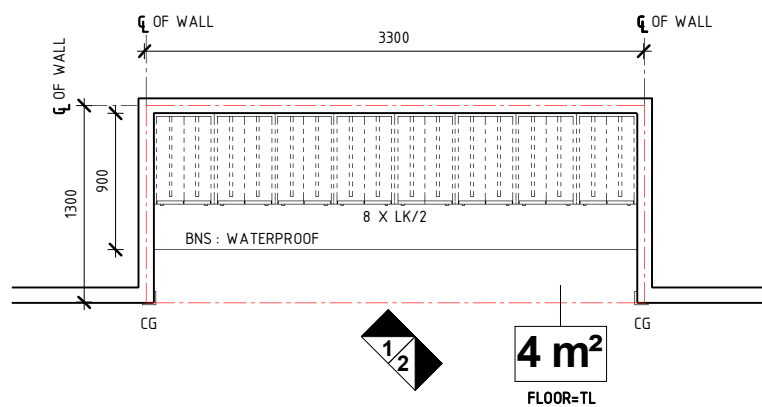

PLAN

OPTION 2

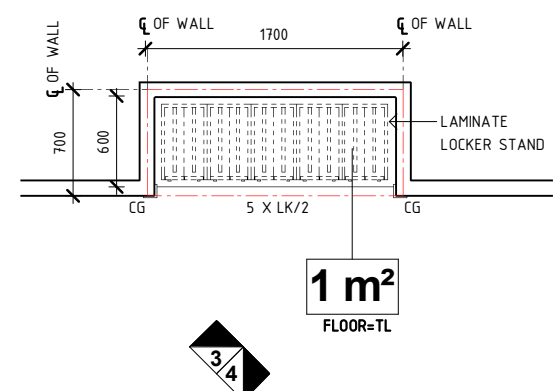

PLAN

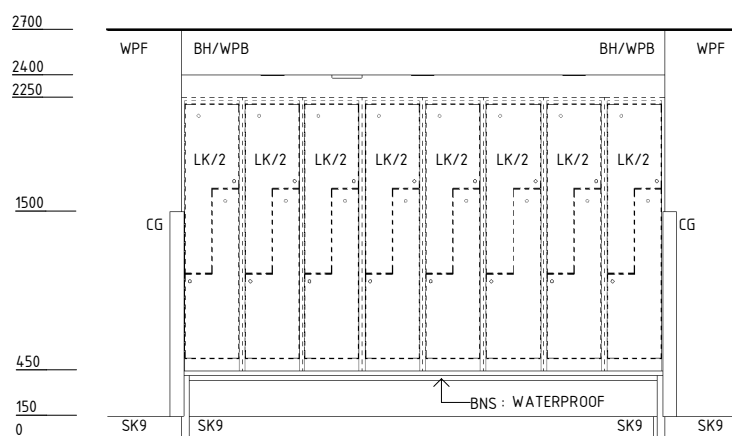

ELEVATION 1

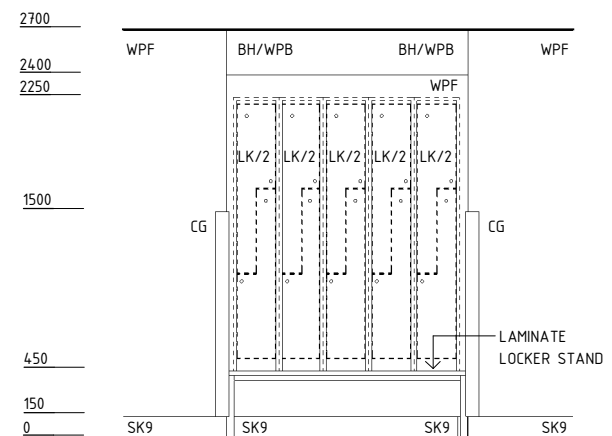

ELEVATION 3

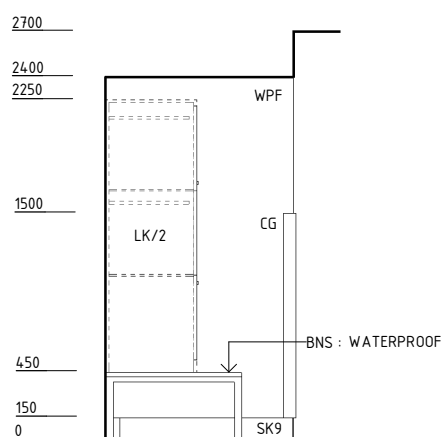

ELEVATION 2

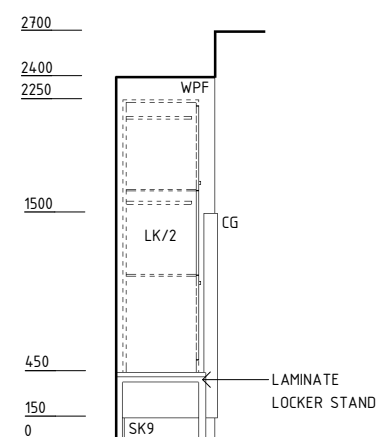

ELEVATION 4

REV	DESCRIPTION	DATE	BY	REV	DESCRIPTION	DATE	BY	COMPATIBILITY																				
1	FIRST ISSUE	24.10.10	CC	4	GENERAL REVISION	25.05.23	AM	iHFG																				
2	GENERAL REVISION	30.08.11	DJ																									
3	GENERAL REVISION	31.10.12	CT																									
<table border="1"> <thead> <tr> <th>DESIGNED</th> <th>APPROVED</th> <th>DATE</th> <th>SCALE(S)</th> <th>SHEET</th> </tr> </thead> <tbody> <tr> <td>AM</td> <td>SA</td> <td>25.05.23</td> <td>1 : 50</td> <td>1 OF 2</td> </tr> <tr> <td colspan="2">REVIT FILE NAME</td> <td colspan="2">PAPER DRAWING ID</td> <td>ISSUE</td> </tr> <tr> <td colspan="2">hydIk-i</td> <td colspan="2">hydIk-i-1</td> <td>4</td> </tr> </tbody> </table>								DESIGNED	APPROVED	DATE	SCALE(S)	SHEET	AM	SA	25.05.23	1 : 50	1 OF 2	REVIT FILE NAME		PAPER DRAWING ID		ISSUE	hydIk-i		hydIk-i-1		4	
DESIGNED	APPROVED	DATE	SCALE(S)	SHEET																								
AM	SA	25.05.23	1 : 50	1 OF 2																								
REVIT FILE NAME		PAPER DRAWING ID		ISSUE																								
hydIk-i		hydIk-i-1		4																								

iHFG Standard Components

Room Layout Sheet

RLS Room Code

hydIk-i

RDS Room Code

hydIk-i

Room Name | **Hydrotherapy Pool Locker Bay**

GENERAL NOTES:

THIS DRAWING TO BE READ IN CONJUNCTION WITH R.D.S. (ROOM DATA SHEETS) WHICH TAKES PRECEDENCE.

ALL SERVICES INDICATED ARE INDICATIVE AND SUBJECTED TO DETAILED PROJECT SPECIFIC ENGINEERING DESIGN.

CEILING LEGEND:

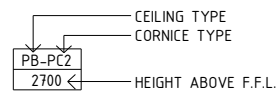

BH/WPB BULKHEAD - WATER RESISTANT PLASTERBOARD, PAINT FINISH
WPB-PC3 WATER RESISTANT PLASTERBOARD FLUSH SET CEILING, PAINT FINISH WITH SQUARE SET CORNICE

--- GRID LINE

ELECTRICAL LEGEND:

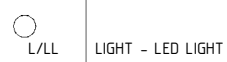

FIRE SERVICES LEGEND:

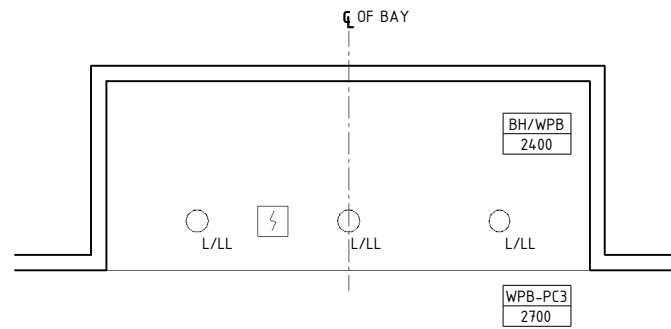

**OPTION 1
REFLECTED CEILING PLAN**

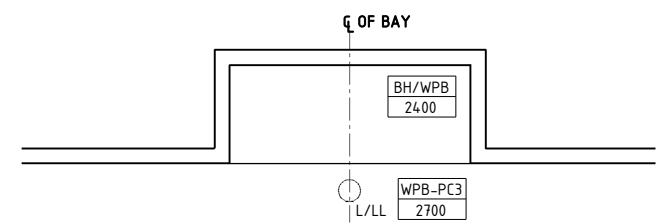

**OPTION 2
REFLECTED CEILING PLAN**

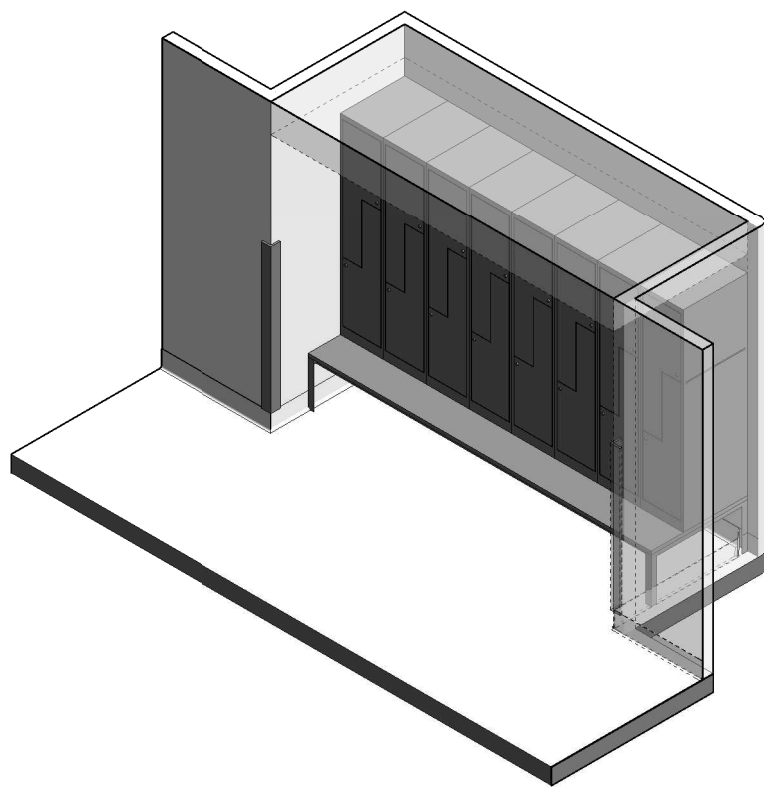

**OPTION 1
ISOMETRIC VIEW**

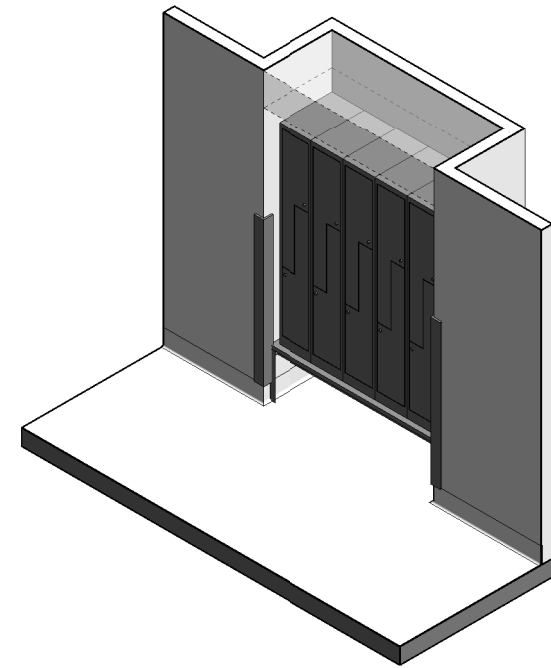

**OPTION 2
ISOMETRIC VIEW**

REV	DESCRIPTION	DATE	BY	REV	DESCRIPTION	DATE	BY	COMPATIBILITY																				
1	FIRST ISSUE	24.10.10	CC	4	GENERAL REVISION	25.05.23	AM	iHFG																				
2	GENERAL REVISION	30.08.11	DJ																									
3	GENERAL REVISION	31.10.12	CT																									
<table border="1"> <thead> <tr> <th>DESIGNED</th> <th>APPROVED</th> <th>DATE</th> <th>SCALE(S)</th> <th>SHEET</th> </tr> </thead> <tbody> <tr> <td>AM</td> <td>SA</td> <td>25.05.23</td> <td>1 : 50</td> <td>2 OF 2</td> </tr> <tr> <td colspan="2">REVIT FILE NAME</td> <td colspan="2">PAPER DRAWING ID</td> <td>ISSUE</td> </tr> <tr> <td colspan="2">hydIk-i</td> <td colspan="2">hydIk-i-2</td> <td>4</td> </tr> </tbody> </table>								DESIGNED	APPROVED	DATE	SCALE(S)	SHEET	AM	SA	25.05.23	1 : 50	2 OF 2	REVIT FILE NAME		PAPER DRAWING ID		ISSUE	hydIk-i		hydIk-i-2		4	
DESIGNED	APPROVED	DATE	SCALE(S)	SHEET																								
AM	SA	25.05.23	1 : 50	2 OF 2																								
REVIT FILE NAME		PAPER DRAWING ID		ISSUE																								
hydIk-i		hydIk-i-2		4																								