

iHFG Standard Components

Room Layout Sheet

Room Name | **Library & Study/ Reading Area, 40m2**

RLS Room Code

Isra-40-i

RDS Room Code

Isra-40-i

- BLR BLIND - ROLLER
- CAC CABLE ACCESS CAP
- CHR/E CHAIR - ERGONOMIC, OFFICE
- CHR/M CHAIR - MEETING
- COM/2 COMMUNICATION OUTLET - DOUBLE
- CPT CARPET
- DK DESK
- KP KICKPLATE
- LS/R LIGHT SWITCH - ROOM
- OP OBSERVATION PANEL
- PAR/WS PARTITION - WORKSTATION
- PFU/M PEDESTAL FILING UNIT - MOBILE
- PO/1 POWER OUTLET - SINGLE
- PO/2 POWER OUTLET - DOUBLE
- PRT PRINTER
- SK7 TIMBER SKIRTING
- SUC SHELVING UNIT - COMPACTUS
- TB/M TABLE - MEETING
- TP/HS TELEPHONE - HANDSET, STANDARD
- WBP/20 WASTE BIN - PAPER, 20 LITRE
- WPF WALL PAINT FINISH
- WS/CMP WORKSTATION - COMPUTER

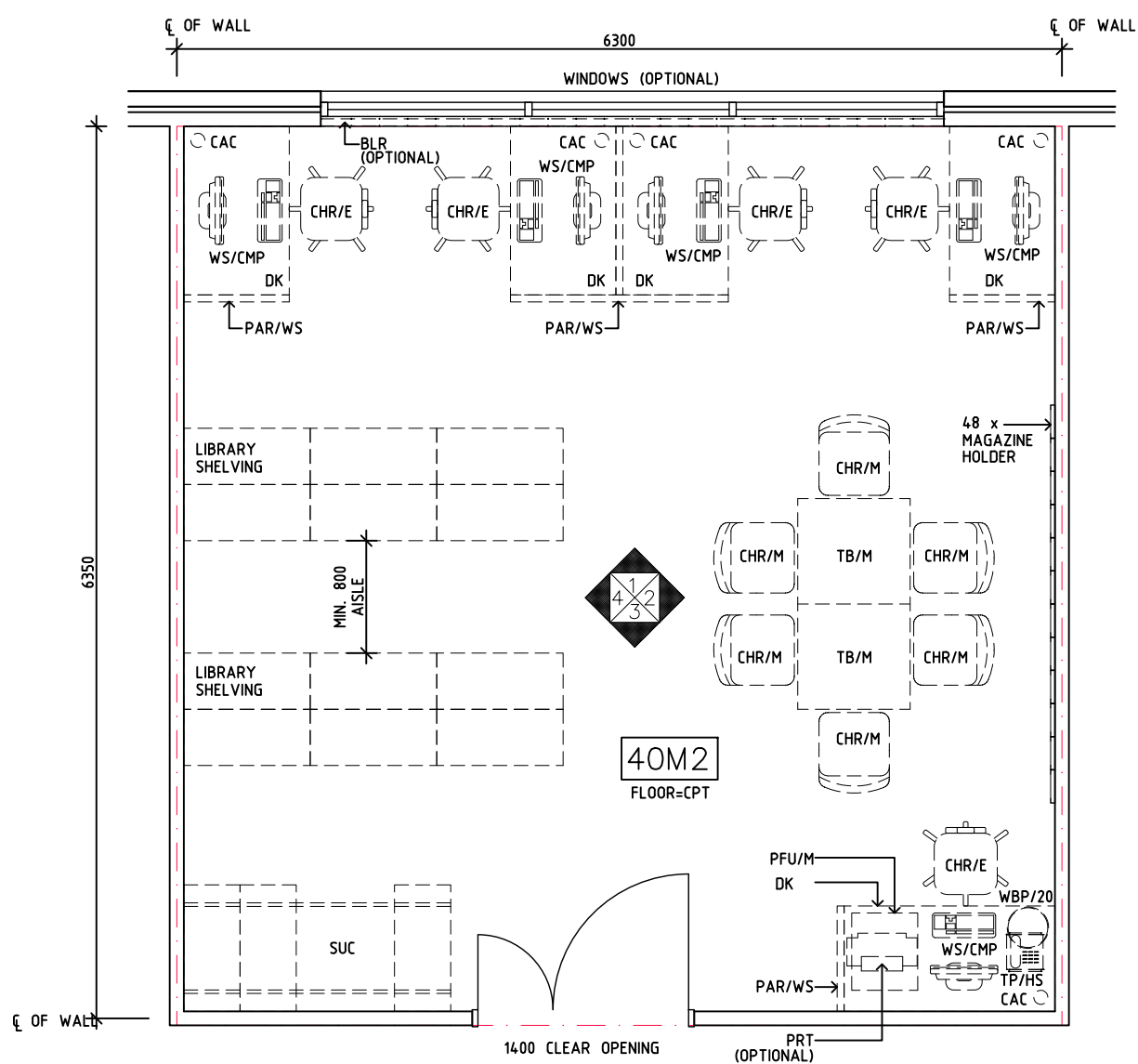

PLAN

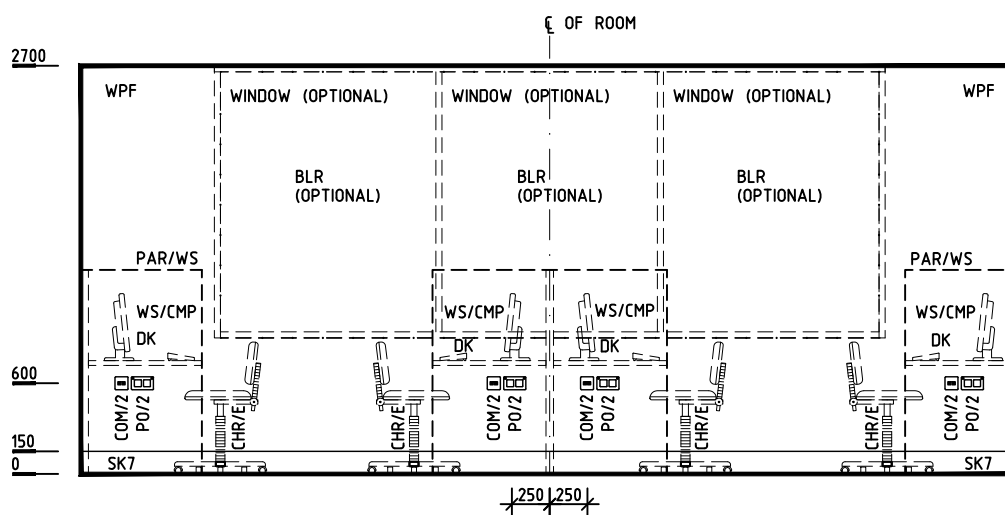

ELEVATION 1

REV	DESCRIPTION	DATE	BY	REV	DESCRIPTION	DATE	BY	COMPATIBILITY
1	FIRST ISSUE	24.10.10	LL	4	GENERAL REVISION	27.01.23	AM	
2	GENERAL REVISION	30.08.11	SK					
3	GENERAL REVISION	31.10.12	CT					



International Health Facility Guidelines at:
www.healthdesign.com.au/iHFG
 Editable version of Standard Components on
 Health Facility Briefing System (HFBS) at:
www.healthdesign.com.au/TAHPI



DESIGNED	APPROVED	DATE	SCALE(S)	SHEET
AM	SA	27.01.23	1:50 in A3	1 OF 3
CAD FILE NAME		PAPER DRAWING ID		ISSUE
Isra-40-i		Isra-40-i		4

iHFG Standard Components

Room Layout Sheet

Room Name | **Library & Study/ Reading Area, 40m2**

RLS Room Code

Isra-40-i

RDS Room Code

Isra-40-i

BLR	BLIND - ROLLER
CAC	CABLE ACCESS CAP
CHR/E	CHAIR - ERGONOMIC, OFFICE
CHR/M	CHAIR - MEETING
COM/2	COMMUNICATION OUTLET - DOUBLE
CPT	CARPET
DK	DESK
KP	KICKPLATE
LS/R	LIGHT SWITCH - ROOM
OP	OBSERVATION PANEL
PAR/WS	PARTITION - WORKSTATION
PFU/M	PEDESTAL FILING UNIT - MOBILE
PO/1	POWER OUTLET - SINGLE
PO/2	POWER OUTLET - DOUBLE
PRT	PRINTER
SK7	TIMBER SKIRTING
SUC	SHELVING UNIT - COMPACTUS
TB/M	TABLE - MEETING
TP/HS	TELEPHONE - HANDSET, STANDARD
WBP/20	WASTE BIN - PAPER, 20 LITRE
WPF	WALL PAINT FINISH
WS/CMP	WORKSTATION - COMPUTER

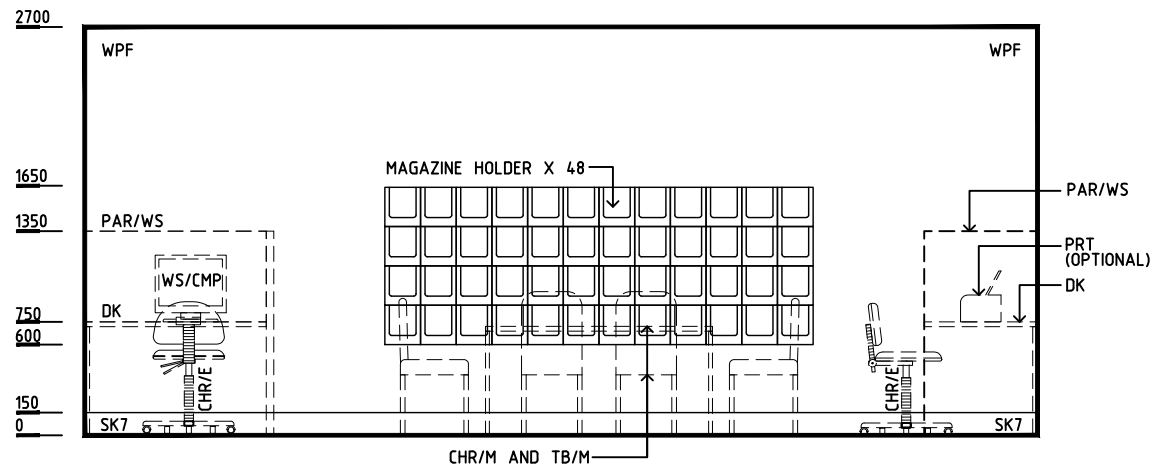

ELEVATION 2

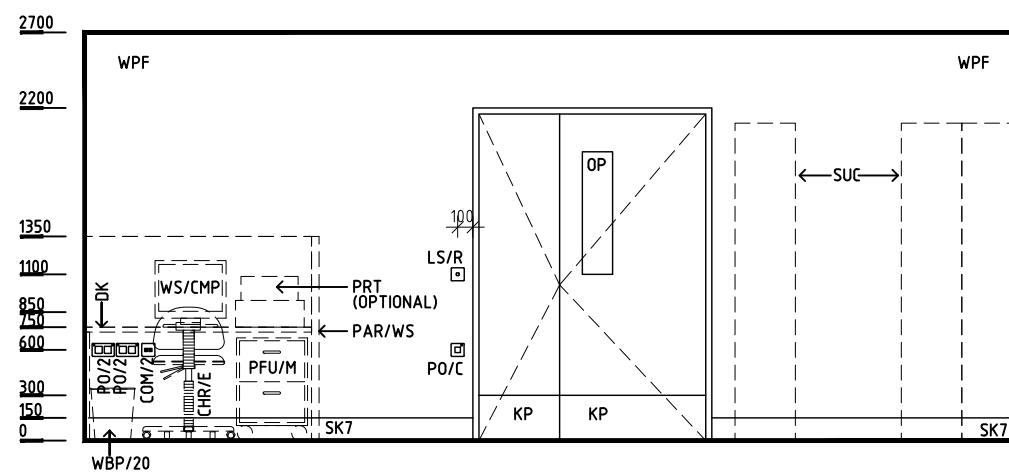

ELEVATION 3

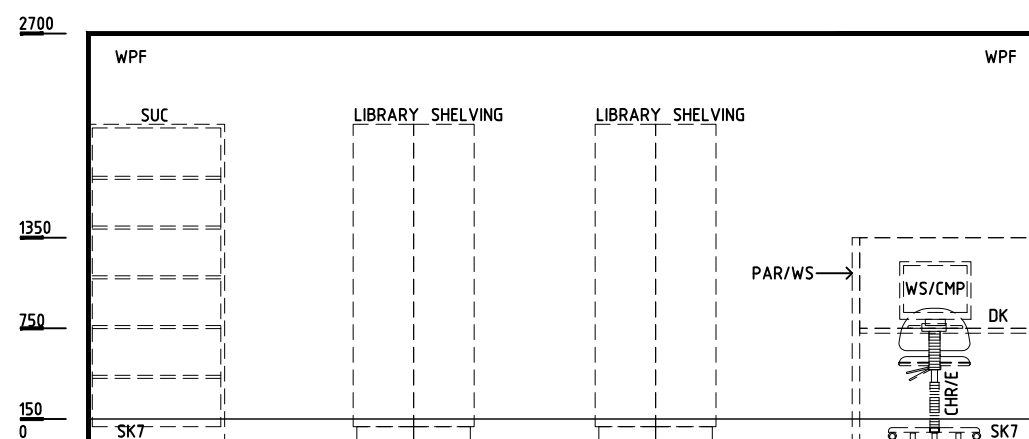

ELEVATION 4

REV	DESCRIPTION	DATE	BY	REV	DESCRIPTION	DATE	BY	COMPATIBILITY
1	FIRST ISSUE	24.10.10	LL	4	GENERAL REVISION	27.01.23	AM	iHFG
2	GENERAL REVISION	30.08.11	SK					
3	GENERAL REVISION	31.10.12	CT					



International Health Facility Guidelines at:
www.healthdesign.com.au/iHFG
 Editable version of Standard Components on
 Health Facility Briefing System (HFBS) at:
www.healthdesign.com.au/TAHPI



DESIGNED	APPROVED	DATE	SCALE(S)	SHEET
AM	SA	27.01.23	1:50 in A3	2 OF 3
CAD FILE NAME		PAPER DRAWING ID		ISSUE
Isra-40-i		Isra-40-i		4

iHFG Standard Components

Room Layout Sheet

Room Name **Library & Study/ Reading Area, 40m2**

RLS Room Code

Isra-40-i

RDS Room Code



Isra-40-i

GENERAL NOTES:

THIS DRAWING TO BE READ IN CONJUNCTION WITH R.D.S. (ROOM DATA SHEETS) WHICH TAKES PRECEDENCE.

ALL SERVICES INDICATED ARE INDICATIVE AND SUBJECTED TO DETAILED PROJECT SPECIFIC ENGINEERING DESIGN.



CEILING LEGEND:

- ACT | ACOUSTIC CEILING TILES
- PC4 | SHADOW ANGLE, POWDERCOAT ALUMINIUM CORNICE
-  | TILE CEILING GRID (600 x 600)
-  | CEILING TYPE
-  | HEIGHT ABOVE F.F.L.

ELECTRICAL LEGEND:

-  | LIGHT - LED LIGHT
- L/LL

MECHANICAL LEGEND:

-  | SUPPLY AIR GRILLE
-  | RETURN AIR GRILLE

FIRE SERVICES LEGEND:

-  | SMOKE DETECTOR
-  | SPRINKLER

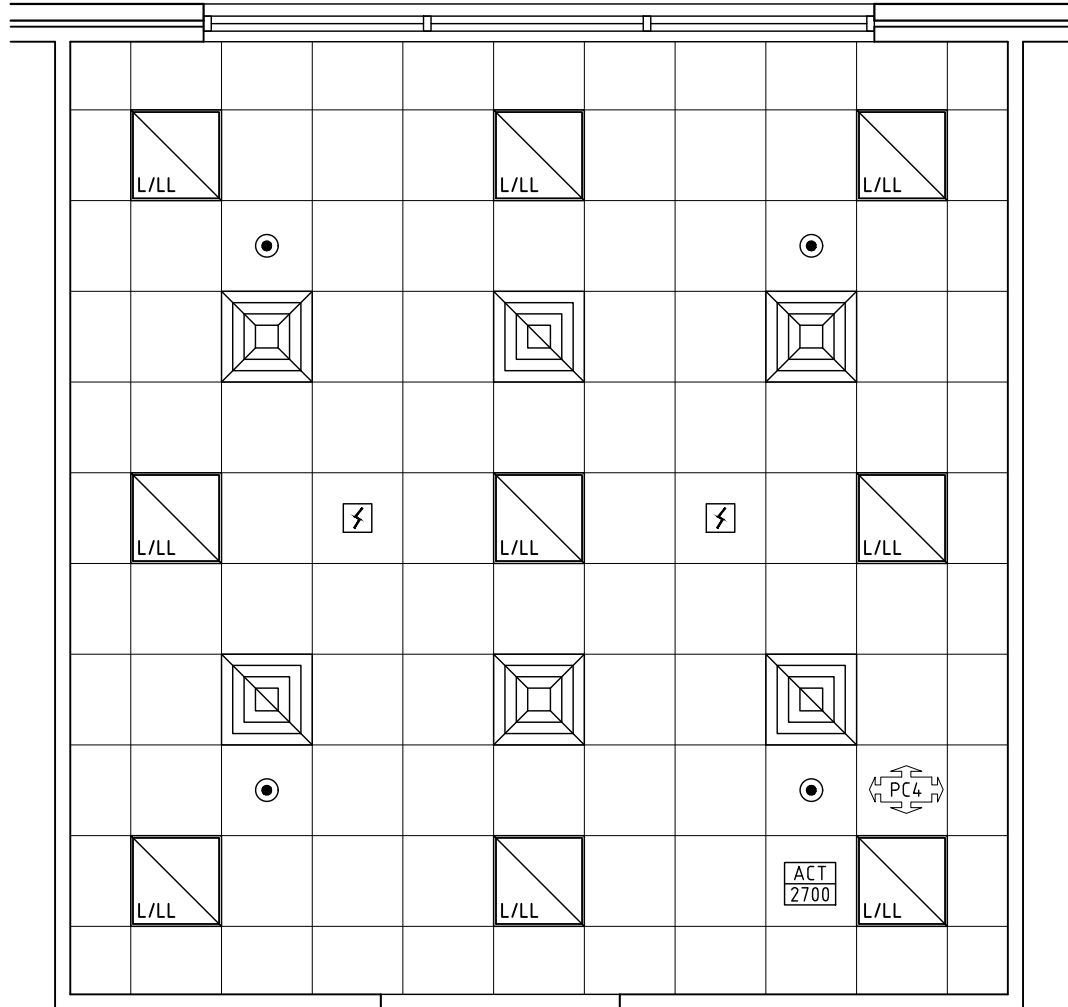

REFLECTED CEILING PLAN

REV	DESCRIPTION	DATE	BY	REV	DESCRIPTION	DATE	BY	COMPATIBILITY
1	FIRST ISSUE	24.10.10	LL	4	GENERAL REVISION	27.01.23	AM	
2	GENERAL REVISION	30.08.11	SK					
3	GENERAL REVISION	31.10.12	CT					