

- AS ADJUSTABLE SHELF
- COH COAT HOOK
- COM/2 COMMUNICATION OUTLET - DOUBLE
- DDG DISPENSER - DISPOSABLE GLOVES
- DHT DISPENSER - HAND TOWEL
- DP DOOR AND DOOR FRAME PROTECTION
- DS DISPENSER - SOAP
- DSA DISPENSER - SOAP ANTISEPTIC
- EC EMERGENCY CALL
- GPO/1 GENERAL POWER OUTLET - SINGLE
- GPO/1 EP GENERAL POWER OUTLET - EMERGENCY, SINGLE
- GPO/2 GENERAL POWER OUTLET - DOUBLE
- GPO/C GENERAL POWER OUTLET - CLEANER
- GPO/S GENERAL POWER OUTLET - SPECIAL, SINGLE
- LS/R/DD LIGHT SWITCH, DIMMER - DOWNLIGHTS
- LS/R/P LIGHT SWITCH - PELMET LIGHT
- LS/R/R LIGHT SWITCH - ROOM
- NA NURSE/STAFF ASSIST CALL
- RCD RESIDUAL CURRENT DEVICE
- SK4 FLOOR VINYL COVERED SKIRTING
- V1 VINYL FLOORING, STANDARD SLIP RESISTANT
- XRV/2 X-RAY VIEWER, 2 SCREENS

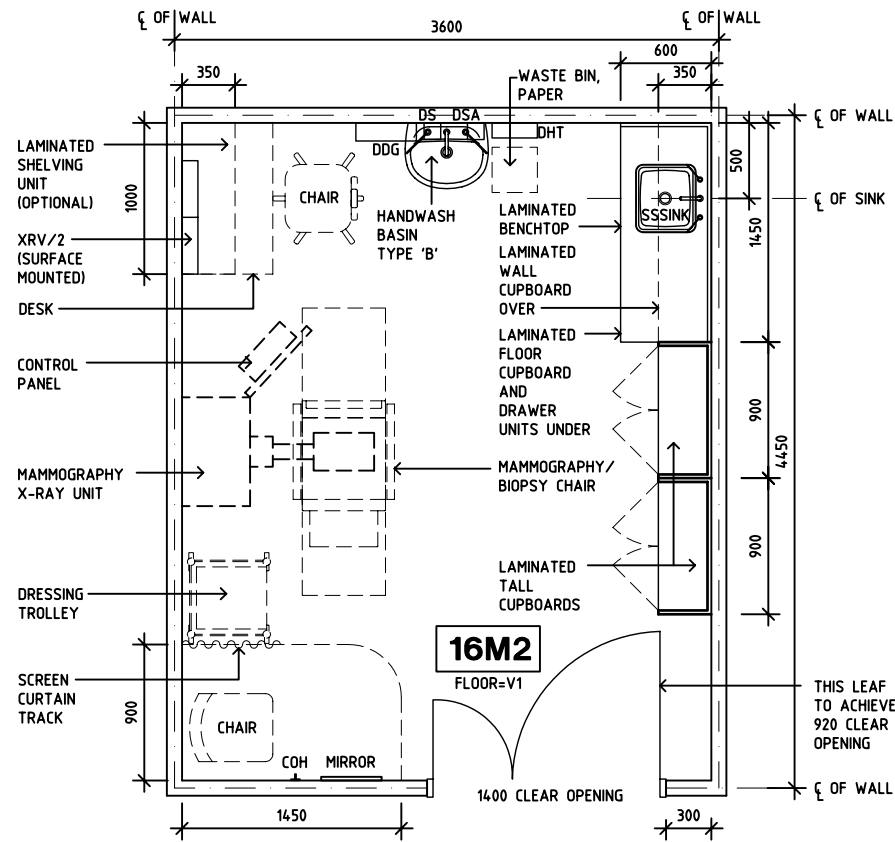

PLAN

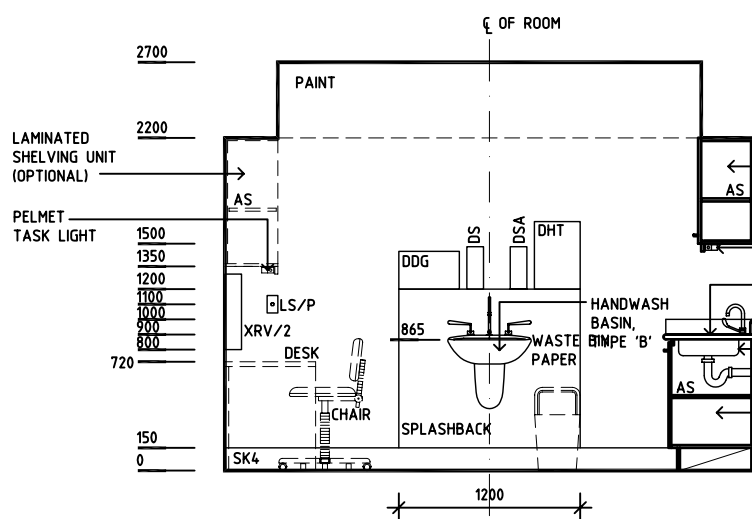

ELEVATION 1

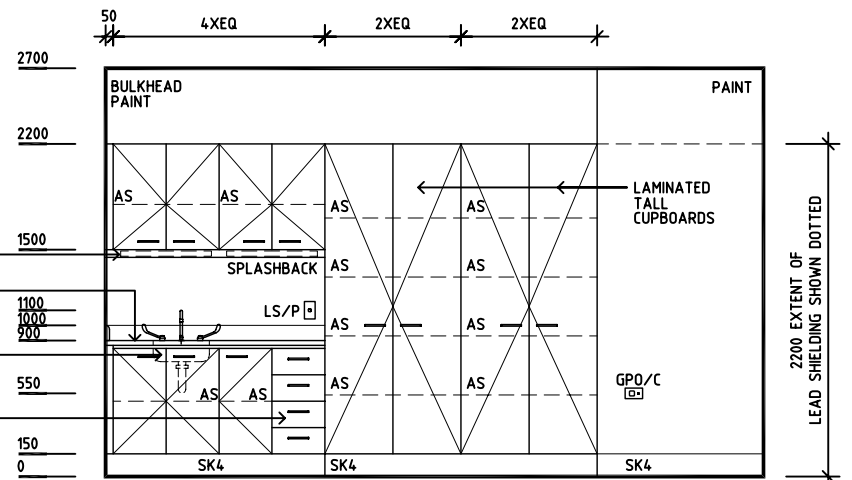

ELEVATION 2

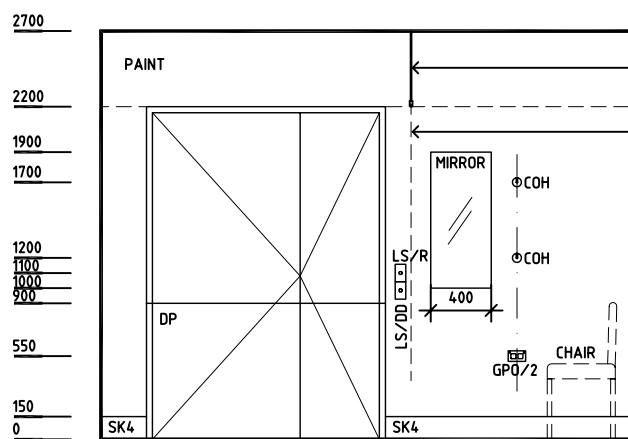

ELEVATION 3

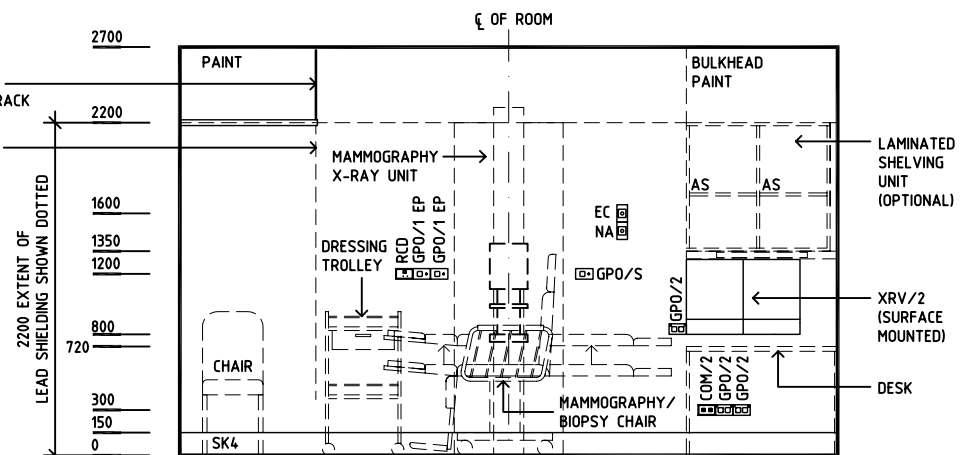

ELEVATION 4

REV	DESCRIPTION	DATE	BY	REV	DESCRIPTION	DATE	BY	REV	DESCRIPTION	DATE	BY
1	FIRST ISSUE	24.10.10	LL								
2	GENERAL REVISION	30.08.11	ASD								
3	GENERAL REVISION	31.10.12	KC								

	DESIGNED	APPROVED	DATE	SCALE(S)	SHEET
	CC	DB	24.10.2010	1:50 in A3	1 of 2
	CAD FILE NAME	PAPER DRAWING ID			ISSUE
MAM-INT-I		MAM-INT-Ia		3	

iHFG Standard Components

Room Layout Sheet

Room Name **Mammography - Interventional**

RLS Room Code **MAM-INT-I**



RDS Room Code **MAM-INT-I**

GENERAL NOTES:



THIS DRAWING TO BE READ IN CONJUNCTION WITH R.D.S. (ROOM DATA SHEETS) WHICH TAKES PRECEDENCE.

ALL SERVICES INDICATED ARE INDICATIVE AND SUBJECTED TO DETAILED PROJECT SPECIFIC ENGINEERING DESIGN.



CEILING LEGEND:

- ACT | ACOUSTIC CEILING TILES
- PBB | PLASTERBOARD BULKHEAD, PAINT
- PC4 | 24mm. SHADOW ANGLE, POWDERCOAT ALUMINIUM CORNICE
-  | TILE CEILING GRID (1200 x 600)
-  | CEILING TYPE
-  | HEIGHT ABOVE F.F.L.



ELECTRICAL LEGEND:

-  | FLUORESCENT DOWNLIGHT - COMPACT COLOUR CORRECTED - CYANOSIS
-  | DECORATIVE DOWNLIGHT - RECESSED, DIMMABLE

MECHANICAL LEGEND:

-  | SUPPLY AIR GRILLE
-  | RETURN AIR OR TRANSFER GRILLE

FIRE SERVICES LEGEND:

-  | SMOKE DETECTOR
-  | SPRINKLER

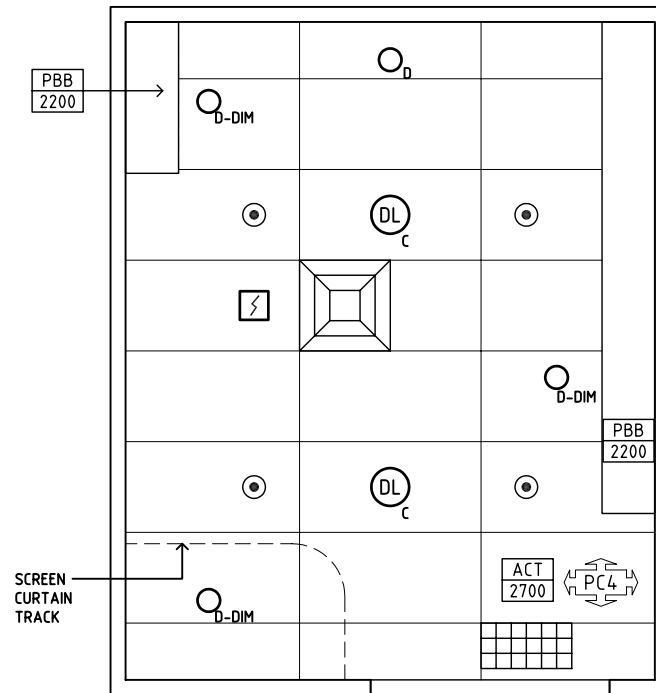

REFLECTED CEILING PLAN

REV	DESCRIPTION	DATE	BY	REV	DESCRIPTION	DATE	BY	REV	DESCRIPTION	DATE	BY
2	GENERAL REVISION	30.08.11	ASD								
3	GENERAL REVISION	31.10.12	KC								

 International Health Facility Guidelines	<small>International Health Facility Guidelines at: www.healthdesign.com.au/iHFG Editable version of Standard Components on Health Facility Briefing System (HFBS) at: www.healthdesign.com.au ©TAHPI</small>				DESIGNED	APPROVED	DATE	SCALE(S)	SHEET
	CC	DB	24.10.2010	1:50 in A3	2 of 2				
	CAD FILE NAME MAM-INT-I		PAPER DRAWING ID MAM-INT-Ib		ISSUE 3				



The International Health Facility Guidelines recommends the use of HFBS “Health Facility Briefing System” to edit all room data sheet information for your project.

HFBS provides edit access to all iHFG standard rooms, and departments, and more than 100 custom report templates.

HFBS Health Facility Briefing System



Briefing Module

The Health Facility Briefing System (HFBS) has numerous modules available via annual subscription. It suits healthcare Architects, Medical Planners, Equipment Planners Project Managers and Health Authorities.

Use the HFBS Briefing Module to quickly drag in health facility departments or pre-configured room templates from the iHFG standard, edit the room features such as finishes, furniture, fittings, fixtures, medical equipment, engineering services. The system can print or download as PDF more than 100 custom reports including room data sheets, schedules, and more...

To learn more about the HFBS web-based Healthcare Briefing and Design Software and to obtain editable versions of the “Standard Components” including Room Data Sheets (RDS) and Room Layout Sheets (RLS) offered on the iHFG website, signup for HFBS using the link below.

Get Started Now:
hfbs.healthdesign.com.au

- ✓ iHFG Room Data Sheets and Departments are instantly editable in the HFBS software available online.
- ✓ You can access hundreds of report templates to print your iHFG room data in HFBS.
- ✓ HFBS has a onetime free 3 day trial available to all new users.

Get Started Now:
hfbs.healthdesign.com.au



HFBS

Health Facility Briefing System

hfbsinfo.com | techsupport@healthdesign.com.au