

iHFG Standard Components

Room Layout Sheet

Room Name **Pharmacy Counter**

RLS Room Code

pha-co-i

RDS Room Code

pha-co-i

BH/PB	BULKHEAD - PLASTERBOARD, PAINT FINISH
BNL	BENCH - LAMINATE
CAC	CABLE ACCESS CAP
CHR/EH	CHAIR - ERGONOMIC, HIGH
CMP	COMPUTER
COM/2	COMMUNICATIONS OUTLET - DOUBLE
CPT	CARPET
CTR	COUNTER TOP
DA	DURESS ALARM
KP	KICKPLATE
LS/R	LIGHT SWITCH - ROOM
LVP	LAMINATED VERTICAL SUPPORT PANEL
OP	OBSERVATION PANEL
PDU/M	PEDESTAL DRAWER UNIT - MOBILE
PO/2	POWER OUTLET - DOUBLE
PO/2E	POWER OUTLET - EMERGENCY, DOUBLE
PRT/N	PRINTER - NETWORKED
SK7	TIMBER SKIRTING
SSSG	SECURITY SCREEN - SAFETY GLASS
TP/HS	TELEPHONE - HANDSET, STANDARD
WBG/20	WASTE BIN - GENERAL, 20 LITRE
WPF	WALL PAINT FINISH

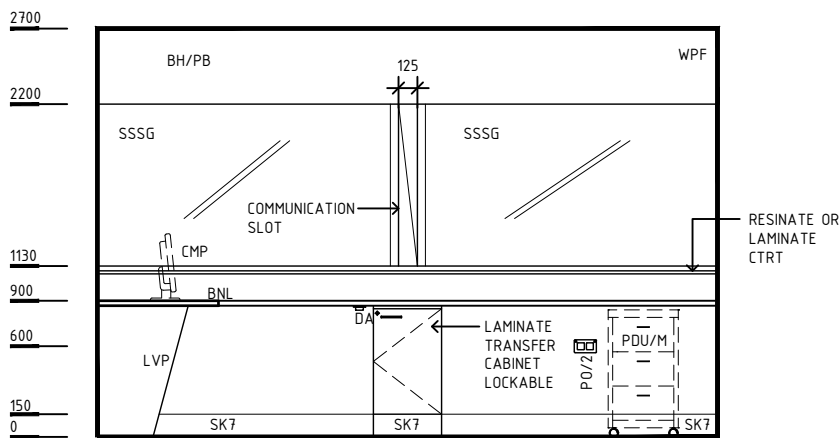

ELEVATION 1

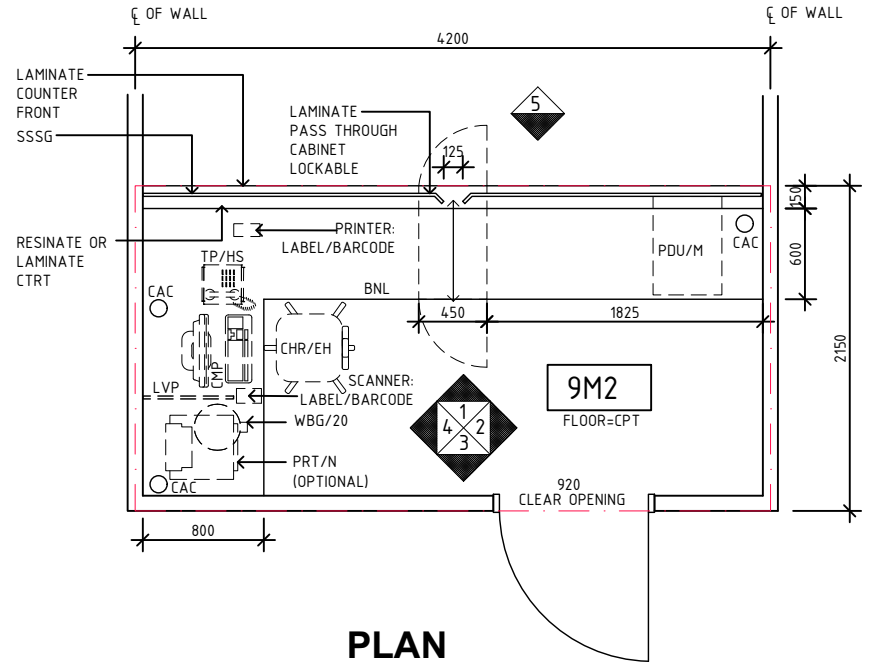

PLAN

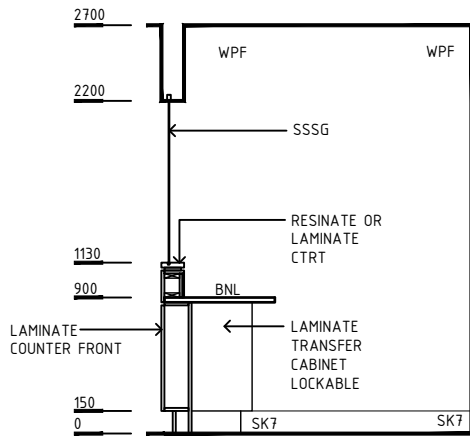

ELEVATION 2

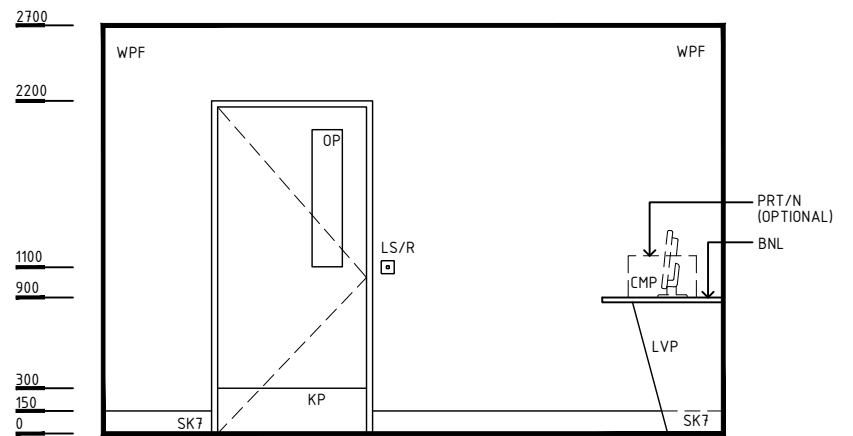

ELEVATION 3

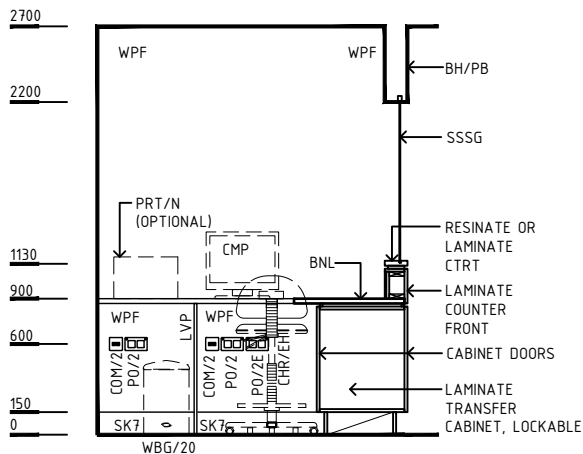

ELEVATION 4

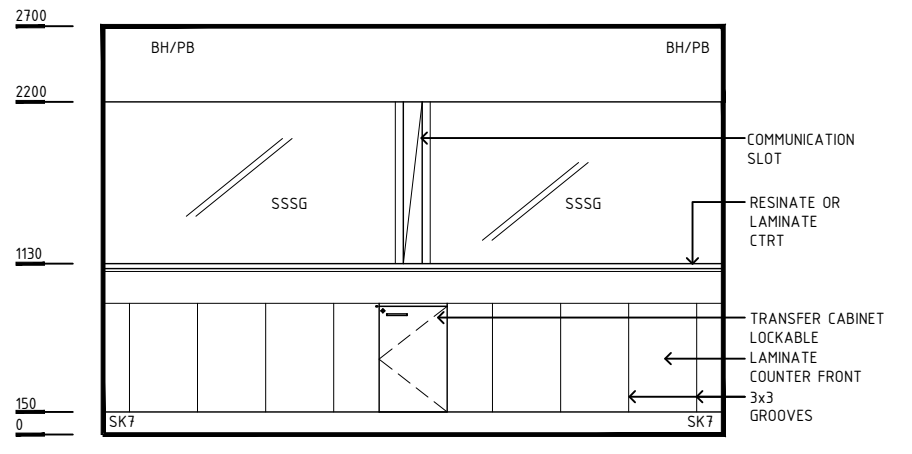

ELEVATION 5

REV	DESCRIPTION	DATE	BY	REV	DESCRIPTION	DATE	BY	COMPATIBILITY
1	FIRST ISSUE	24.10.10	LL	4	GENERAL REVISION	06.12.22	BV	iHFG
2	GENERAL REVISION	30.08.11	SK					
3	GENERAL REVISION	31.10.12	CT					

iHFG Standard Components

Room Layout Sheet

Room Name **Pharmacy Counter**

RLS Room Code

pha-co-i

RDS Room Code



pha-co-i



GENERAL NOTES:

THIS DRAWING TO BE READ IN CONJUNCTION WITH R.D.S. (ROOM DATA SHEETS) WHICH TAKES PRECEDENCE.

ALL SERVICES INDICATED ARE INDICATIVE AND SUBJECT TO DETAILED PROJECT SPECIFIC ENGINEERING DESIGN.

CEILING LEGEND:



- ACT | ACOUSTIC CEILING TILES
- BH/PB | BULKHEAD - PLASTERBOARD, PAINT FINISH
- PC4 | POWDERCOAT ALUMINIUM CORNICE, SHADOW LINE
-  | TILE CEILING GRID (600 x 600)
-  | GRID LINE

 ← CEILING TYPE
 ← HEIGHT ABOVE F.F.L.



ELECTRICAL LEGEND:

 | LIGHT - LED LIGHT

MECHANICAL LEGEND:

 | SUPPLY AIR GRILLE
 | RETURN AIR GRILLE

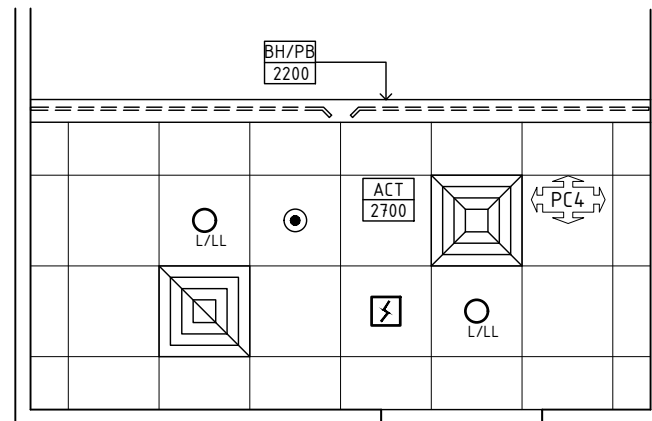

FIRE SERVICES LEGEND:

 | SMOKE DETECTOR
 | SPRINKLER



REFLECTED CEILING PLAN

REV	DESCRIPTION	DATE	BY	REV	DESCRIPTION	DATE	BY	COMPATIBILITY
1	FIRST ISSUE	24.10.10	LL	4	GENERAL REVISION	06.12.22	BV	
2	GENERAL REVISION	30.08.11	SK					
3	GENERAL REVISION	31.10.12	CT					

 International Health Facility Guidelines	International Health Facility Guidelines at: www.healthdesign.com.au/iHFG Editable version of Standard Components on Health Facility Briefing System (HFBS) at: www.healthdesign.com.au ©TAHPI			DESIGNED	APPROVED	DATE	SCALE(S)	SHEET
	BV	RH		06.12.22	1:50 in A3	2 OF 2		
				CAD FILE NAME	PAPER DRAWING ID		ISSUE	
				pha-co-i	pha-co-i-2		4	

This document is for advisory purpose only