

iHFG Standard Components

Room Layout Sheet

Room Name **Radiotherapy Bunker Control Room**

RLS Room Code

rad-bctr-i

RDS Room Code

rad-bctr-i

AS	ADJUSTABLE SHELF
BH/PB	BULKHEAD - PLASTERBOARD
BNL	BENCH - LAMINATE
CAC	CABLE ACCESS CAP
CHR/EH	CHAIR - ERGONOMIC, HIGH
CMP	COMPUTER
COH	COAT HOOK
COM/2	COMMUNICATION OUTLET - DOUBLE
IM/CC	IMAGING - CONSOLE, CONTROL
INT	INTERCOM
KP	KICKPLATE
L/PT	LIGHT - PELMET TASK LIGHT
LS/R	LIGHT SWITCH - ROOM
LVP	LAMINATED VERTICAL SUPPORT PANEL
MON/CCTV	MONITOR - CLOSED CIRCUIT TELEVISION
OP	OBSERVATION PANEL
PDU/M	PEDESTAL DRAWER UNIT - MOBILE
PO/2U	UNINTERRUPTED POWER SUPPLY - DOUBLE
PRT/N	PRINTER - NETWORKED
SK4	FLOOR VINYL COVERED SKIRTING
SUOA	SHELVING UNIT - OVER BENCH, ADJUSTABLE
TP/HS	TELEPHONE - HANDSET, STANDARD
V1	VINYL FLOORING STANDARD
WPF	WALL PAINT FINISH

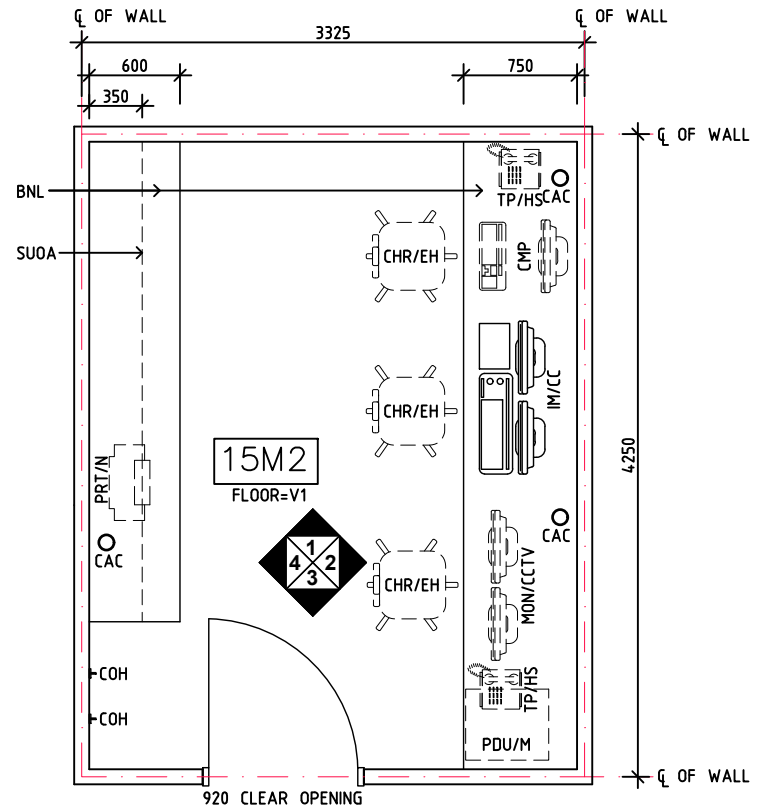

PLAN

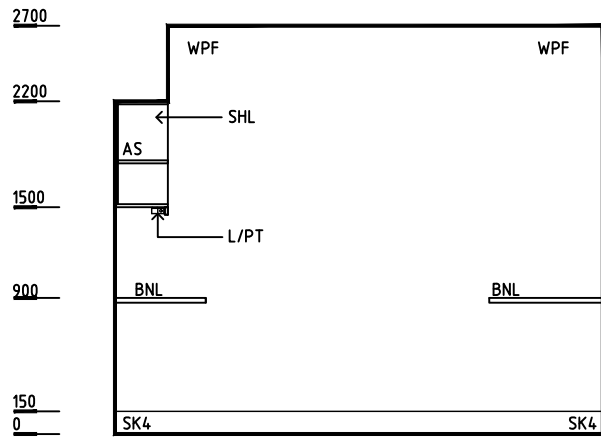

ELEVATION 1

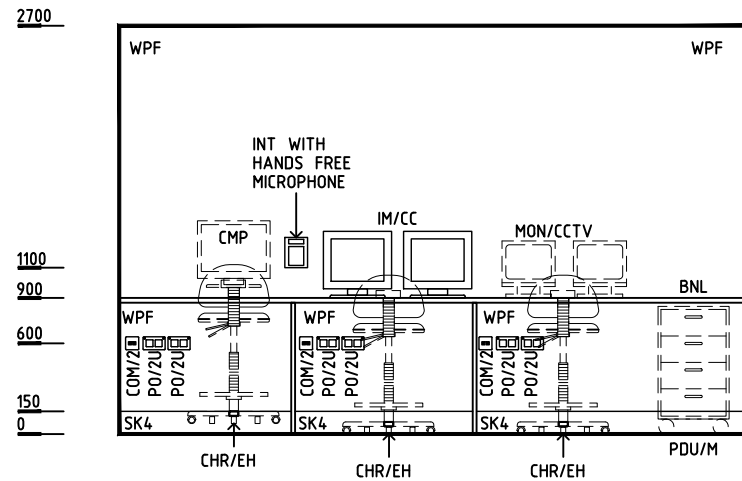

ELEVATION 2

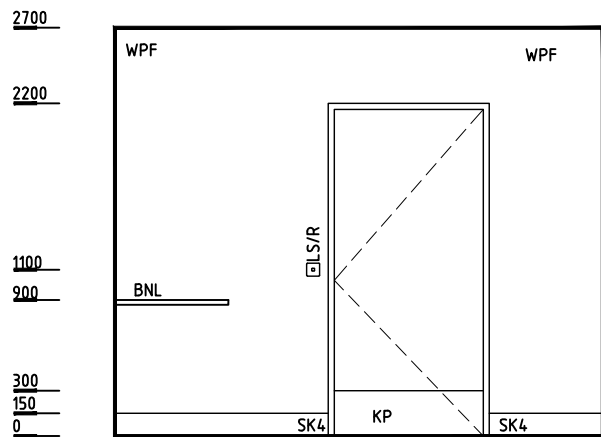

ELEVATION 3

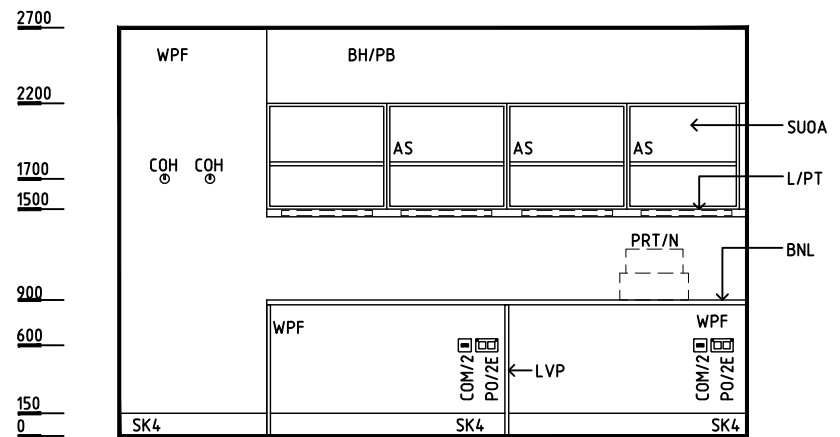

ELEVATION 4

REV	DESCRIPTION	DATE	BY	REV	DESCRIPTION	DATE	BY	COMPATIBILITY
1	FIRST ISSUE	24.10.10	LL	4	GENERAL REVISION	03.11.22	BK	
2	GENERAL REVISION	30.08.11	SK					
3	GENERAL REVISION	31.10.12	KC					

iHFG Standard Components

Room Layout Sheet

Room Name **Radiotherapy Bunker Control Room**

RLS Room Code

rad-bctr-i

RDS Room Code



rad-bctr-i

GENERAL NOTES:

THIS DRAWING TO BE READ IN CONJUNCTION WITH R.D.S. (ROOM DATA SHEETS) WHICH TAKES PRECEDENCE.

ALL SERVICES INDICATED ARE INDICATIVE AND SUBJECTED TO DETAILED PROJECT SPECIFIC ENGINEERING DESIGN.



CEILING LEGEND:

- ACT | ACOUSTIC CEILING TILES
- PCS | POWDERCOAT ALUMINIUM CORNICE, FLUSHED AGAINST WALL
- BH/PB | BULKHEAD - PLASTERBOARD, PAINT FINISH
-  | TILE CEILING GRID (600 x 600)
-  | CEILING TYPE
HEIGHT ABOVE F.F.L.



ELECTRICAL LEGEND:

-  | LIGHT: LED LIGHT

MECHANICAL LEGEND:

-  | SUPPLY AIR GRILLE
-  | RETURN AIR GRILLE

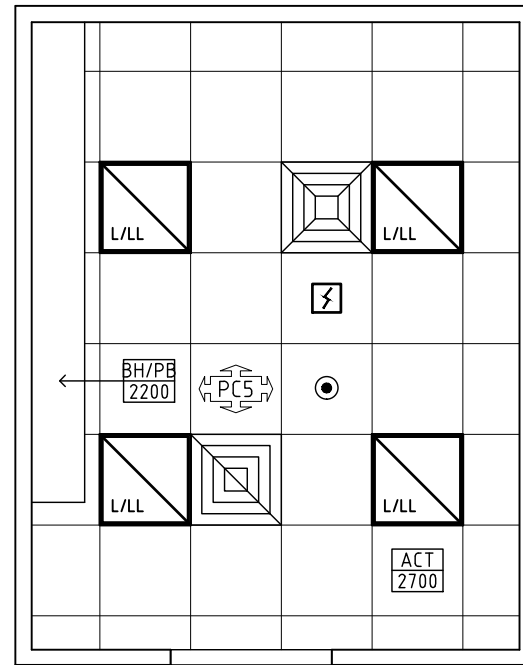

FIRE SERVICES LEGEND:

-  | SMOKE DETECTOR
-  | SPRINKLER



REFLECTED CEILING PLAN

REV	DESCRIPTION	DATE	BY	REV	DESCRIPTION	DATE	BY	COMPATIBILITY
1	FIRST ISSUE	24.10.10	LL	4	GENERAL REVISION	03.11.22	BK	
2	GENERAL REVISION	30.08.11	SK					
3	GENERAL REVISION	31.10.12	KC					

	International Health Facility Guidelines	International Health Facility Guidelines at: www.healthdesign.com.au/iHFG Editable version of Standard Components on Health Facility Briefing System (HFBS) at: www.healthdesign.com.au ©TAHPI		DESIGNED	APPROVED	DATE	SCALE(S)	SHEET
				BK	DB	03.11.22	1:50 in A3	2 OF 2
				CAD FILE NAME	PAPER DRAWING ID		ISSUE	
				rad-bctr-i	rad-bctr-i-2		1	