

iHFG Standard Components

Room Layout Sheet

RLS Room Code

shd-i

RDS Room Code

shd-i

Room Name | Shower - Accessible, 4m2

- COH COAT HOOK
- CSHR CURTAIN - SHOWER
- CTS CURTAIN TRACK - SHOWER
- DDG DISPENSER - DISPOSABLE GLOVES
- DFP DOOR AND DOOR FRAME PROTECTION
- EC EMERGENCY CALL
- FW FLOOR WASTE
- GR GRAB RAIL
- LS/R LIGHT SWITCH - ROOM
- PC PATIENT CALL
- S/SH SOAP/ SHAMPOO HOLDER
- SAC STAFF ASSIST CALL
- SHRH SHOWER - HAND HELD SHOWER HEAD
- SK4 FLOOR VINYL COVERED SKIRTING
- SSFU SHOWER SEAT - FOLD UP
- TR TOWEL RAIL
- V3 VINYL FLOORING, NON SLIP - STUDDED
- WPF WALL PAINT FINISH
- WT WALL TILE

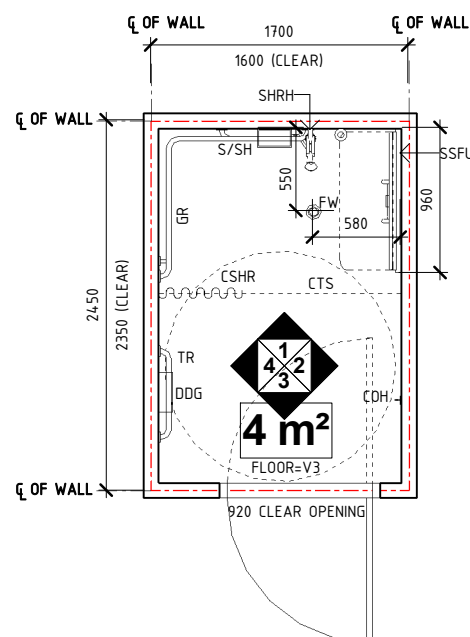

PLAN

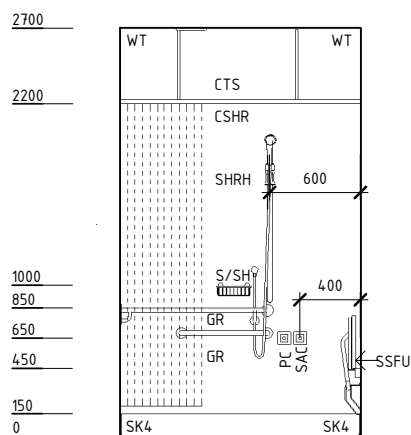

ELEVATION 1

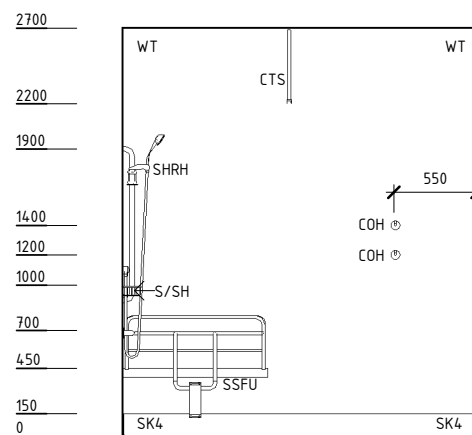

ELEVATION 2

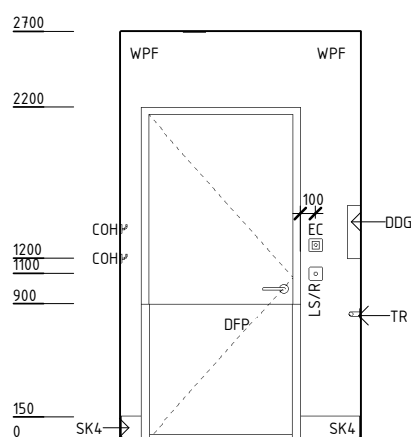

ELEVATION 3

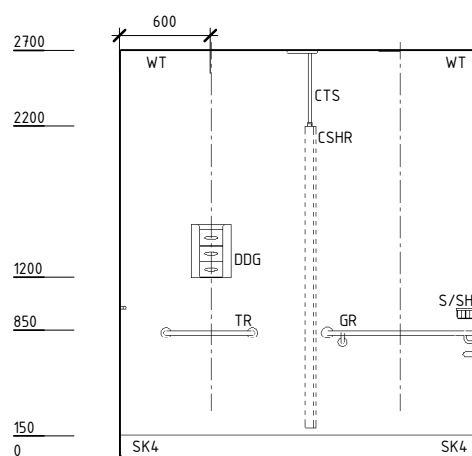

ELEVATION 4

REV	DESCRIPTION	DATE	BY	REV	DESCRIPTION	DATE	BY	COMPATIBILITY
1	FIRST ISSUE	24.10.10	LL	4	GENERAL REVISION	27.01.23	SS	
2	GENERAL REVISION	30.08.11	KC					
3	GENERAL REVISION	31.10.12	SK					



International Health Facility Guidelines at:
www.healthdesign.com.au/iHFG
 Editable version of Standard Components on
 Health Facility Briefing System (HFBS) at:
www.healthdesign.com.au/TAHPI



DESIGNED	APPROVED	DATE	SCALE(S)	SHEET
SS	SA	27.01.23	1 : 50	1 OF 2
REVIT FILE NAME		PAPER DRAWING ID		ISSUE
shd-i		shd-i-1		4

iHFG Standard Components

Room Layout Sheet

RLS Room Code

shd-i

RDS Room Code

shd-i

Room Name

Shower - Accessible, 4m2

GENERAL NOTES:

THIS DRAWING TO BE READ IN CONJUNCTION WITH R.D.S. (ROOM DATA SHEETS) WHICH TAKES PRECEDENCE.

ALL SERVICES INDICATED ARE INDICATIVE AND SUBJECTED TO DETAILED PROJECT SPECIFIC ENGINEERING DESIGN.

CEILING LEGEND:

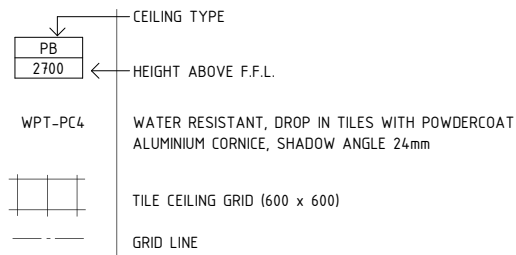

ELECTRICAL LEGEND:



MECHANICAL LEGEND:

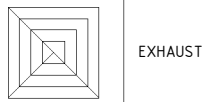

FIRE SERVICES LEGEND:

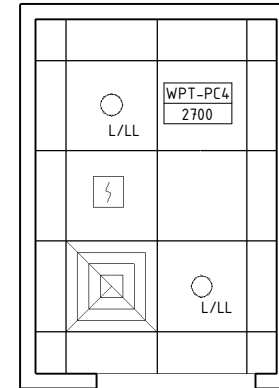

REFLECTED CEILING PLAN

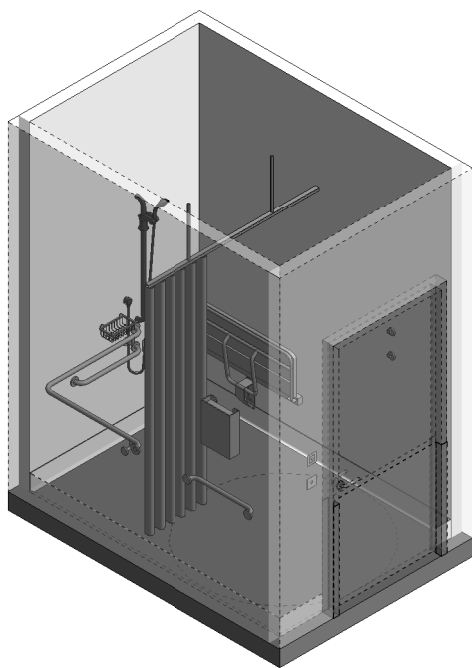

ISOMETRIC VIEW 01

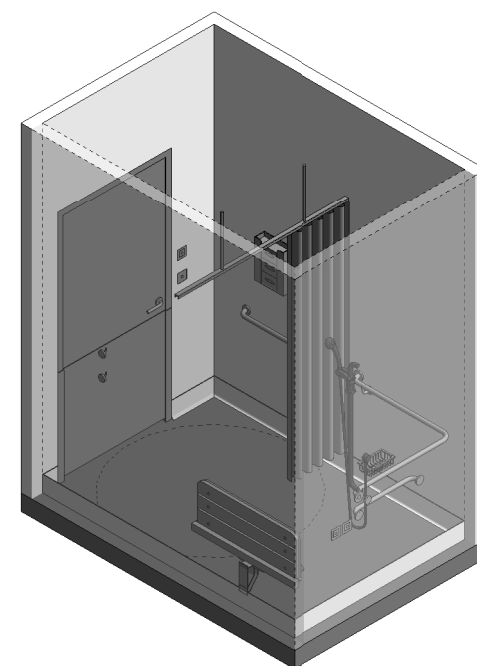

ISOMETRIC VIEW 02

REV	DESCRIPTION	DATE	BY	REV	DESCRIPTION	DATE	BY	COMPATIBILITY																				
1	FIRST ISSUE	24.10.10	LL	4	GENERAL REVISION	27.01.23	SS	iHFG																				
2	GENERAL REVISION	30.08.11	KC																									
3	GENERAL REVISION	31.10.12	SK																									
<table border="1"> <thead> <tr> <th>DESIGNED</th> <th>APPROVED</th> <th>DATE</th> <th>SCALE(S)</th> <th>SHEET</th> </tr> </thead> <tbody> <tr> <td>SS</td> <td>SA</td> <td>27.01.23</td> <td>1 : 50</td> <td>2 OF 2</td> </tr> <tr> <td colspan="2">REVIT FILE NAME</td> <td colspan="2">PAPER DRAWING ID</td> <td>ISSUE</td> </tr> <tr> <td colspan="2">shd-i</td> <td colspan="2">shd-i-2</td> <td>4</td> </tr> </tbody> </table>								DESIGNED	APPROVED	DATE	SCALE(S)	SHEET	SS	SA	27.01.23	1 : 50	2 OF 2	REVIT FILE NAME		PAPER DRAWING ID		ISSUE	shd-i		shd-i-2		4	
DESIGNED	APPROVED	DATE	SCALE(S)	SHEET																								
SS	SA	27.01.23	1 : 50	2 OF 2																								
REVIT FILE NAME		PAPER DRAWING ID		ISSUE																								
shd-i		shd-i-2		4																								

This document is for advisory purpose only