

iHFG Standard Components

Room Layout Sheet

Room Name | **Store - General, 12m2**

RLS Room Code

stgn-12-i

RDS Room Code

stgn-12-i

DFP	DOOR AND DOOR FRAME PROTECTION
LS/R	LIGHT SWITCH - ROOM
PO/2	POWER OUTLET - DOUBLE
SHM	METAL SHELVING
SK4	FLOOR VINYL COVERED SKIRTING
V1	VINYL FLOORING, STANDARD SLIP RESISTANT
WPF	WALL PAINT FINISH

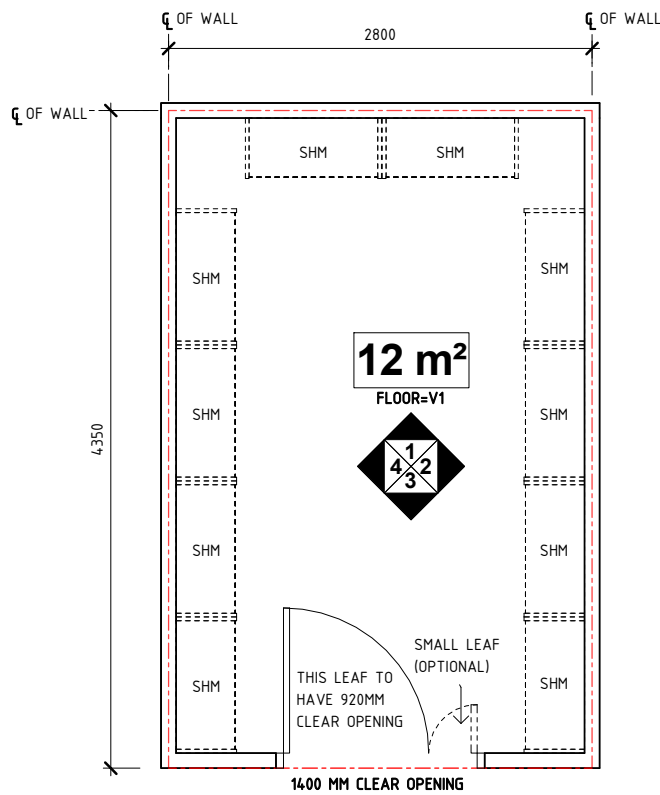

PLAN

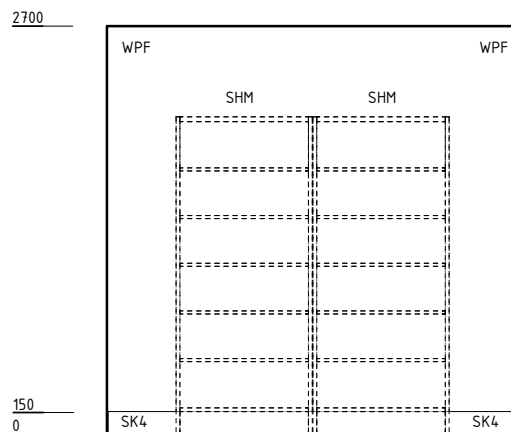

ELEVATION 1

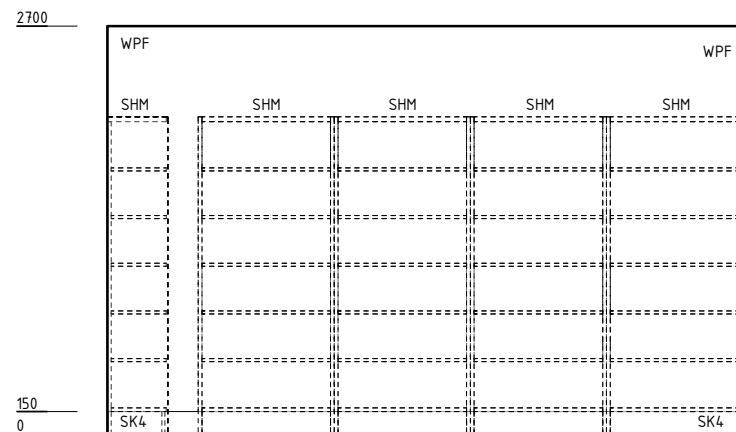

ELEVATION 2

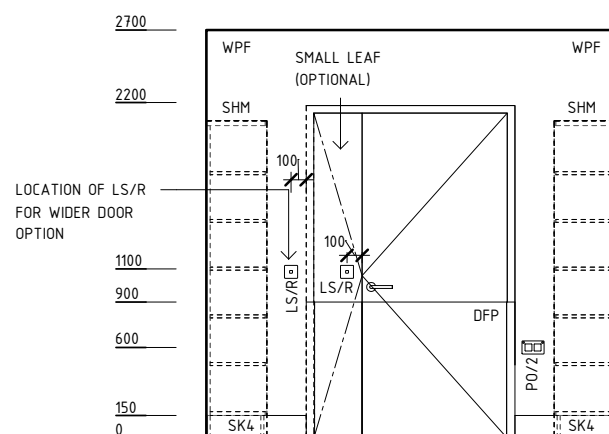

ELEVATION 3

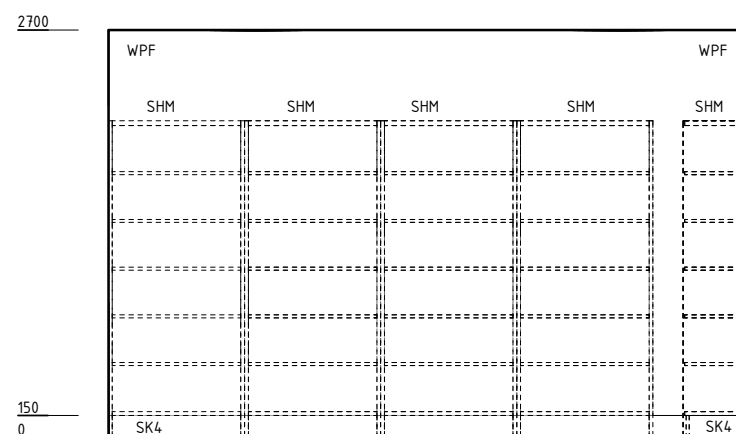

ELEVATION 4

REV	DESCRIPTION	DATE	BY	REV	DESCRIPTION	DATE	BY	COMPATIBILITY																				
1	FIRST ISSUE	24.04.10	LL	4	GENERAL REVISION	25.05.23	SS																					
2	GENERAL REVISION	30.08.11	SK																									
3	GENERAL REVISION	31.10.12	KC																									
International Health Facility Guidelines International Health Facility Guidelines at: www.healthdesign.com.au/iHFG Editable version of Standard Components on: Health Facility Briefing System (HFBS) at: www.healthdesign.com.au ©TAHPI								<table border="1"> <tr> <th>DESIGNED</th> <th>APPROVED</th> <th>DATE</th> <th>SCALE(S)</th> <th>SHEET</th> </tr> <tr> <td>SS</td> <td>SA</td> <td>25.05.23</td> <td>1 : 50</td> <td>1 OF 2</td> </tr> <tr> <th colspan="2">REVIT FILE NAME</th> <th colspan="2">PAPER DRAWING ID</th> <th>ISSUE</th> </tr> <tr> <td colspan="2">stgn-12-i</td> <td colspan="2">stgn-12-i-1</td> <td>4</td> </tr> </table>	DESIGNED	APPROVED	DATE	SCALE(S)	SHEET	SS	SA	25.05.23	1 : 50	1 OF 2	REVIT FILE NAME		PAPER DRAWING ID		ISSUE	stgn-12-i		stgn-12-i-1		4
DESIGNED	APPROVED	DATE	SCALE(S)	SHEET																								
SS	SA	25.05.23	1 : 50	1 OF 2																								
REVIT FILE NAME		PAPER DRAWING ID		ISSUE																								
stgn-12-i		stgn-12-i-1		4																								

iHFG Standard Components

Room Layout Sheet

RLS Room Code

stgn-12-i

RDS Room Code

stgn-12-i

Room Name

Store - General, 12m²

GENERAL NOTES:

THIS DRAWING TO BE READ IN CONJUNCTION WITH R.D.S. (ROOM DATA SHEETS) WHICH TAKES PRECEDENCE.

ALL SERVICES INDICATED ARE INDICATIVE AND SUBJECT TO DETAILED PROJECT SPECIFIC ENGINEERING DESIGN.

CEILING LEGEND:

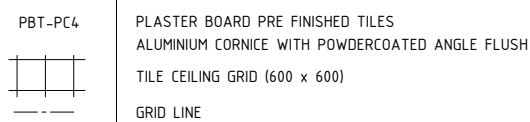
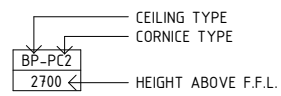

ELECTRICAL LEGEND:

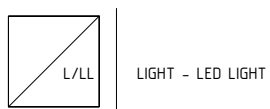

MECHANICAL LEGEND:



FIRE SERVICES LEGEND:

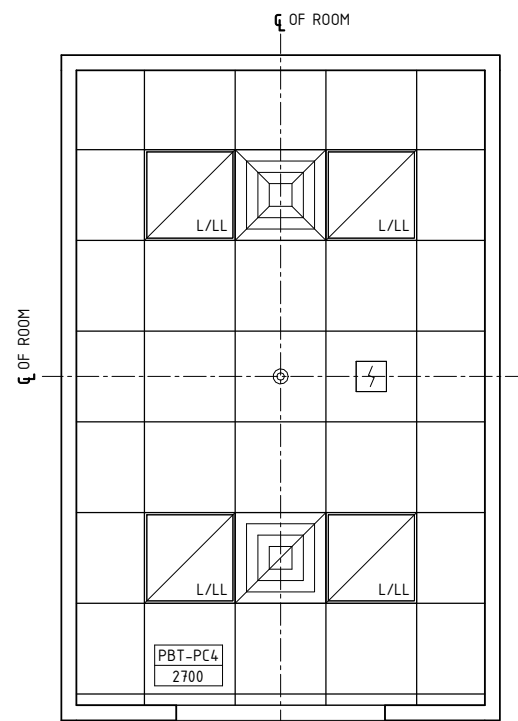
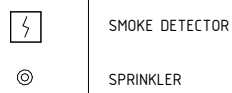

REFLECTED CEILING PLAN

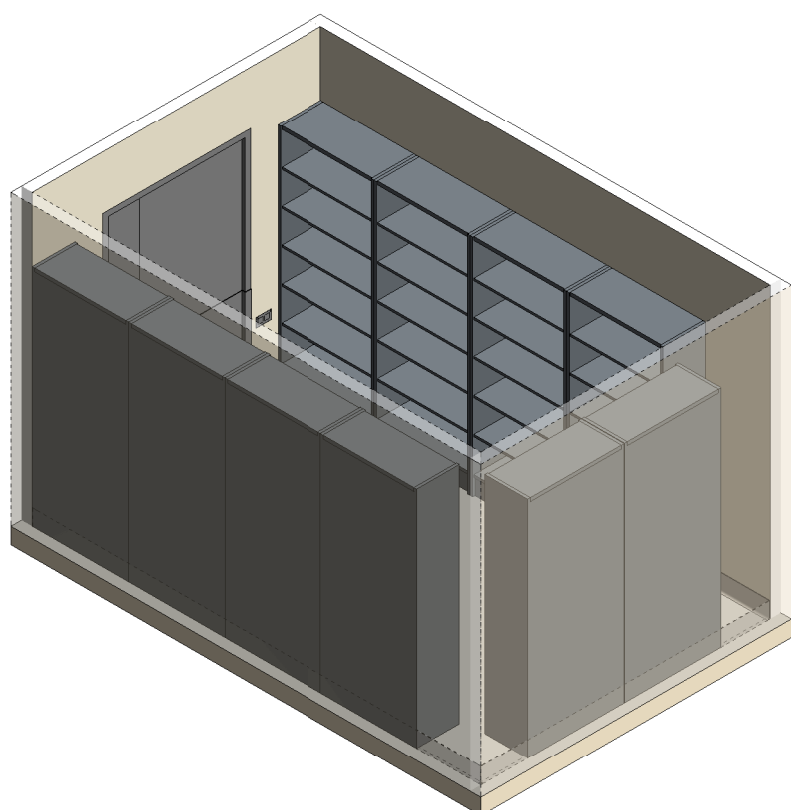

ISOMETRIC VIEW 01

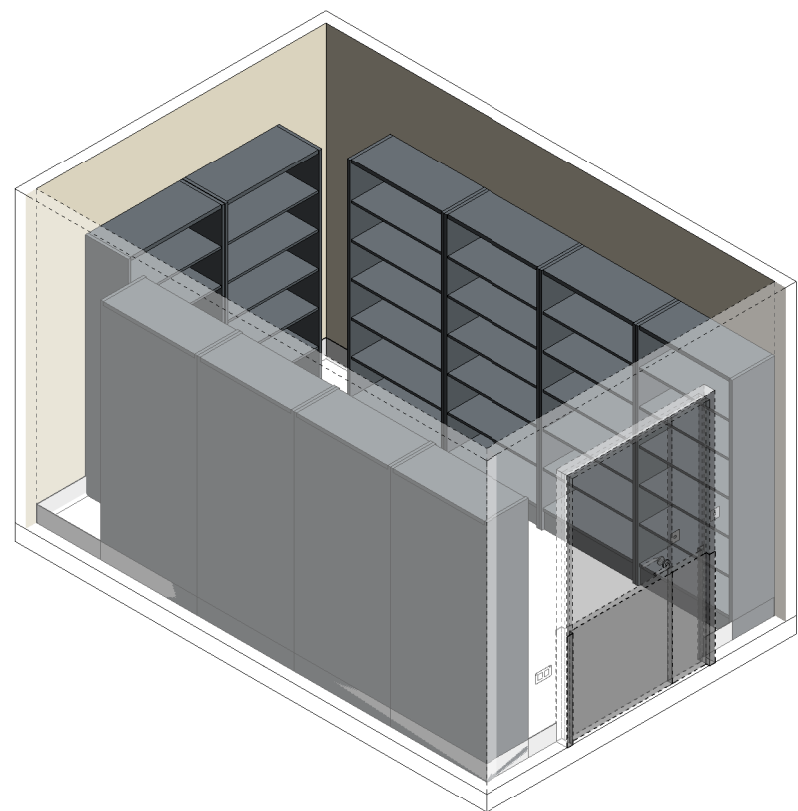

ISOMETRIC VIEW 02

REV	DESCRIPTION	DATE	BY	REV	DESCRIPTION	DATE	BY	COMPATIBILITY																				
1	FIRST ISSUE	24.04.10	LL	4	GENERAL REVISION	25.05.23	SS																					
2	GENERAL REVISION	30.08.11	SK																									
3	GENERAL REVISION	31.10.12	KC																									
International Health Facility Guidelines International Health Facility Guidelines at: www.healthdesign.com.au/iHFG Editable version of Standard Components on Health Facility Briefing System (HFBS) at: www.healthdesign.com.au ©TAHPI								<table border="1"> <tr> <th>DESIGNED</th> <th>APPROVED</th> <th>DATE</th> <th>SCALE(S)</th> <th>SHEET</th> </tr> <tr> <td>SS</td> <td>SA</td> <td>25.05.23</td> <td>1 : 50</td> <td>2 OF 2</td> </tr> <tr> <th colspan="2">REVIT FILE NAME</th> <th colspan="2">PAPER DRAWING ID</th> <th>ISSUE</th> </tr> <tr> <td colspan="2">stgn-12-i</td> <td colspan="2">stgn-12-i-2</td> <td>4</td> </tr> </table>	DESIGNED	APPROVED	DATE	SCALE(S)	SHEET	SS	SA	25.05.23	1 : 50	2 OF 2	REVIT FILE NAME		PAPER DRAWING ID		ISSUE	stgn-12-i		stgn-12-i-2		4
DESIGNED	APPROVED	DATE	SCALE(S)	SHEET																								
SS	SA	25.05.23	1 : 50	2 OF 2																								
REVIT FILE NAME		PAPER DRAWING ID		ISSUE																								
stgn-12-i		stgn-12-i-2		4																								