

iHFG Standard Components

Room Layout Sheet

Room Name **Store Photocopy/ Stationery**

RLS Room Code

stps-8-i

RDS Room Code

stps-8-i

AS	ADJUSTABLE SHELF
BH	BULKHEAD
BNL	BENCH - LAMINATE
CBD/FAL	CUPBOARD - FULL HEIGHT, ADJUSTABLE SHELVES, LOCKABLE
CBD/UBL	CUPBOARD - UNDER BENCH, LOCKABLE
COM/2	COMMUNICATION OUTLET- DOUBLE
CPT	CARPET
FS	FIXED SHELF
FXM	FACSIMILE MACHINE
KP	KICKPLATE
PO/2	POWER OUTLET-DOUBLE
L/PT	LIGHT - PELMET TASK LIGHT
LS/P	LIGHT SWITCH - PELMET TASK LIGHT
LS/R	LIGHT SWITCH - ROOM
PRT/N	PRINTER-NETWORKED
SK1	MDF SKIRTING
SK4	FLOOR VINYL COVED SKIRTING
SUOA	SHELVING UNIT - OVER BENCH, ADJUSTABLE
V1	VINYL FLOORING, STANDARD SLIP RESISTANT
WBF/50	WASTE BIN - FLIPTOP, 50L
WPF	WALL PAINT FINISH

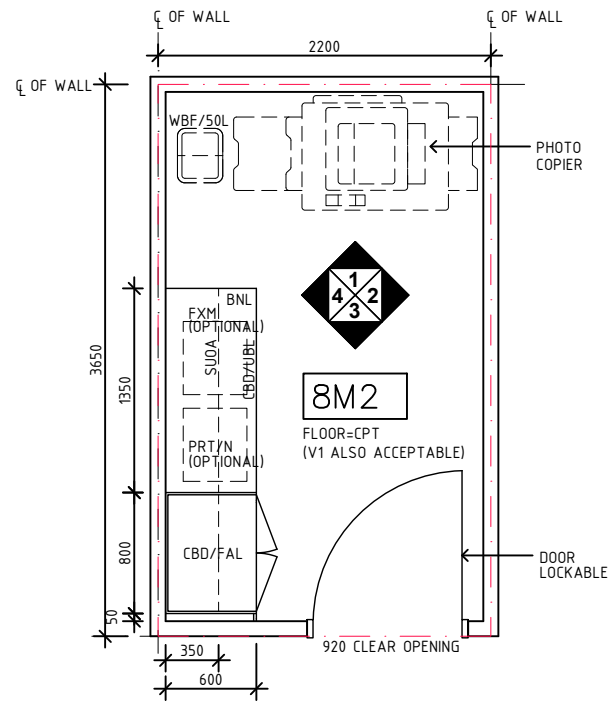

PLAN

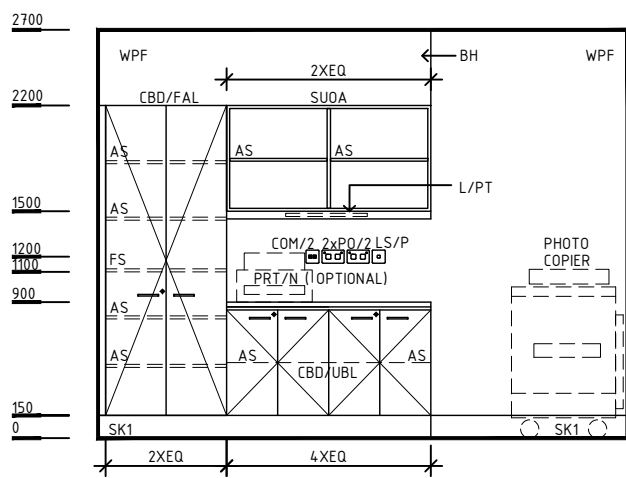

ELEVATION 1

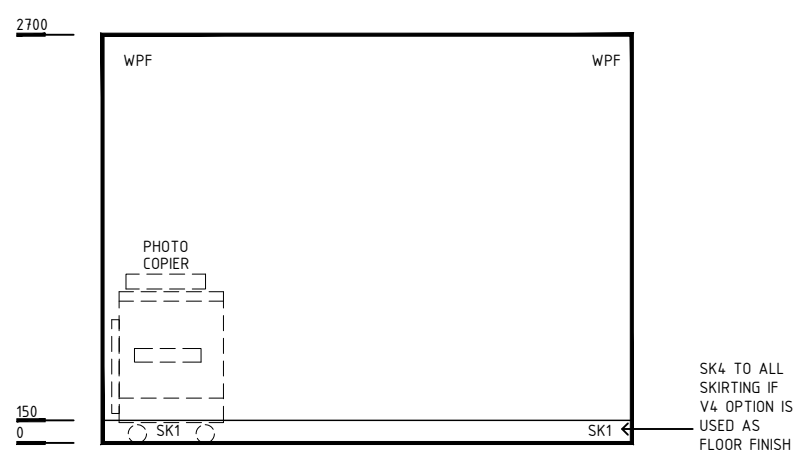

ELEVATION 2

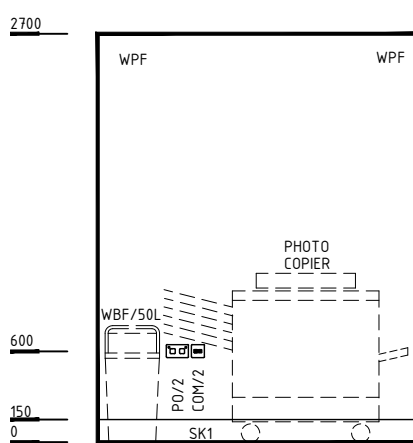

ELEVATION 3

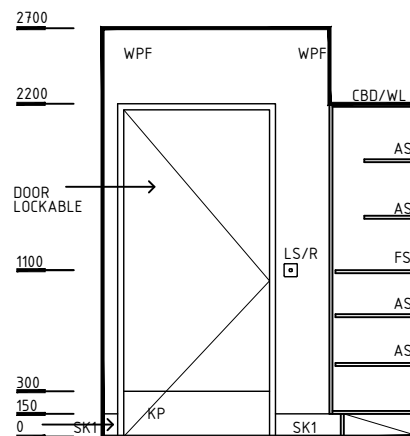

ELEVATION 4

REV	DESCRIPTION	DATE	BY	REV	DESCRIPTION	DATE	BY	COMPATIBILITY
1	FIRST ISSUE	24.04.10	LL	4	GENERAL REVISION	09.09.22	BV	
2	GENERAL REVISION	30.08.11	SK					
3	GENERAL REVISION	31.10.12	KC					



International Health Facility Guidelines at:
www.healthdesign.com.au/ihfg
 Editable version of Standard Components on
 Health Facility Briefing System (HFBS) at:
www.healthdesign.com.au/TAHPI



DESIGNED	APPROVED	DATE	SCALE(S)	SHEET
BV	RH	09.09.22	1:50 in A3	1 of 2
CAD FILE NAME		PAPER DRAWING ID		ISSUE
stps-8-i		stps-8-i-1		4

This document is for advisory purpose only

iHFG Standard Components

Room Layout Sheet

Room Name

Store Photocopy/ Stationery

RLS Room Code

stps-8-i

RDS Room Code

stps-8-i

GENERAL NOTES:

THIS DRAWING TO BE READ IN CONJUNCTION WITH R.D.S. (ROOM DATA SHEETS) WHICH TAKES PRECEDENCE.

ALL SERVICES INDICATED ARE INDICATIVE & SUBJECTED TO DETAILED PROJECT SPECIFIC ENGINEERING DESIGN.

CEILING LEGEND:

ACT ACOUSTIC CEILING TILES
 BH/PB BULKHEAD - PLASTERBOARD, PAINT FINISH
 PC4 SHADOW ANGLE, POWDERCOAT ALUMINIUM CORNICE



 TILE CEILING GRID (600 x 600)

 CEILING TYPE
 2700 HEIGHT ABOVE F.F.L.



ELECTRICAL LEGEND:

 LIGHT - LED LIGHT
 L/LL

MECHANICAL LEGEND:

 SUPPLY AIR GRILLE
 EXHAUST AIR GRILLE

FIRE SERVICES LEGEND:

 SMOKE DETECTOR
 SPRINKLER

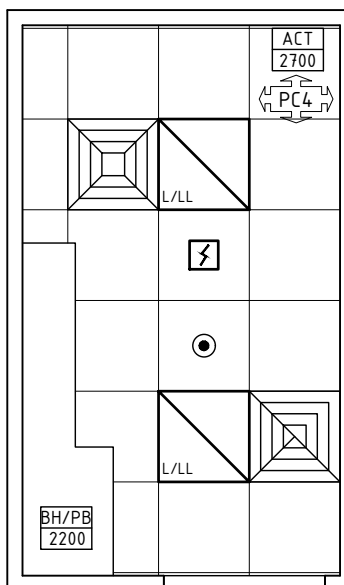

REFLECTED CEILING PLAN

REV	DESCRIPTION	DATE	BY	REV	DESCRIPTION	DATE	BY	COMPATIBILITY
1	FIRST ISSUE	24.04.10	LL	4	GENERAL REVISION	09.09.22	BV	
2	GENERAL REVISION	30.08.11	SK					
3	GENERAL REVISION	31.10.12	KC					

DESIGNED	APPROVED	DATE	SCALE(S)	SHEET
BV	RH	09.09.22	1:50 in A3	2 of 2

CAD FILE NAME	PAPER DRAWING ID	ISSUE
stps-8-i	stps-8-i-2	1